

PLUS LINE

COMMERCIAL SOLUTIONS
TH-R290-C50-3P | 50 kW



AIR-TO-WATER HEAT PUMP
PLUS C LINE (MONOBLOCK)
TH-R290-C50-3P

INSTALLATION AND USER MANUAL



R290



THERMATEC
PLUS LINE

THERMATEC
PLUS LINE

Our primary goal is customer satisfaction, which is why we introduce devices made from components of renowned global manufacturers and materials that ensure long-lasting and trouble-free operation. From the beginning of our company's operation, we have placed great emphasis on the design of our products.

We believe that devices such as heat pumps, hydraulic cabinet assemblies, or even domestic hot water storage tanks should be a part of good design. To meet these expectations, our devices present themselves exceptionally well against the backdrop of our customers' dream homes and offices.

We attach great importance to the utility, quality of workmanship, and durability of our products, ensuring that we deliver devices prepared for years of trouble-free and efficient operation.

TABLE OF CONTENTS







1. SAFETY SYMBOLS	4
2. SAFE INSTALLATION AND OPERATION PRINCIPLES	5
3. DESCRIPTION AND APPLICATION	10
4. ADDITIONAL ACCESSORIES	10
5. OPERATING PRINCIPLE	10
6. HEAT PUMP INSTALLATION	12
7. TECHNICAL PARAMETERS OF THE HEAT PUMP	16
8. ELECTRICAL CONNECTION	17
9. OPERATION	19
10. INSPECTION AND MAINTENANCE	19
11. ERROR CODES	20
12. TROUBLESHOOTIN	22
13. ELECTRICAL SCHEMATIC	23
14. INSTRUCTIONS FOR THE WIRED TOUCH CONTROLLER	24
15. THERMATEC CASCADE INSTRUCTIONS	34
16. WI-FI CONNECTION	36
17. DISPOSAL	38
18. SERVICE	38

IMPORTANT!

- This Installation and User Manual contains essential information regarding the safe use, proper installation, and operation of the THERMATEC heat pump.
- Before using the product, you must read this manual carefully and thoroughly understand its contents.
- The Installation and User Manual should be kept for future reference.
- You must provide this manual to any subsequent owner or user of the THERMATEC heat pump.
- During the use of the THERMATEC heat pump, you must adhere to applicable regulations and safety guidelines.
- Due to the rapid development of our products, the content of this manual may change without prior notice.

1. SAFETY SYMBOLS

The safety symbols and warning signs below are used to emphasize particularly important information regarding safety issues and proper use of the THERMATEC heat pump:

SYMBOL	MEANING
 DANGER	Immediate danger! Failure to comply may result in death or serious bodily injury.
 WARNING	Possible danger! Failure to comply may result in death or serious bodily injury.
 ATTENTION	Hazardous situation! Non-compliance may result in minor or moderate bodily injury or property damage.
	Please read the manual.
	Warning of electric shock.
	Caution hot surface!

2. RULES FOR SAFE INSTALLATION AND USE

The heat pump is designed for heating buildings with high heat demand.

The device can only be used for the purpose for which it has been explicitly intended; any other use should be considered inappropriate and consequently dangerous. The installation of the device must be carried out in accordance with current standards and regulations, following the manufacturer's instructions and by qualified personnel. Improper installation of the device may result in injuries to people and animals and other property damage for which the manufacturer is not liable.



Do not entrust the use of the device to children or people with limited physical, sensory, or mental abilities, or someone without the required experience and knowledge, unless they are supervised or have been instructed about the use of this device by a person responsible for their safety. The device should be stored out of reach of children.

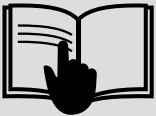

Before starting work, carefully read this manual with understanding and follow the rules contained therein.

2.1. PRECAUTIONS

Incorrect operations can lead to serious consequences, such as serious injuries, severe accidents, or even death. Improper operation can damage the device or affect its functioning.



Please carefully read the labels on the device. If you notice any abnormalities during use such as unusual noise, smell, smoke, temperature increase, refrigerant leaks, fire, etc., immediately disconnect the power and contact the installer, Authorized Service Partner, or the manufacturer's service to repair the device. If necessary, contact the local fire and rescue services immediately.

1. The device must not be installed independently by the user. It must be installed by a certified installer. Otherwise, it may result in an accident or affect the device's performance.
2. Without professional supervision and qualifications, individuals are prohibited from dismantling the device. Otherwise, it may lead to damage or an accident.
3. Do not use or store flammable materials such as hair spray, paint, gasoline, alcohol, etc., near the device. Otherwise, it may cause a fire.
4. The main power switch of the device should be located in a place inaccessible to children.
5. Do not touch the device with wet hands while it is under power. Otherwise, it may result in an electric shock.
6. The device requires a separate power switch to avoid sharing the same circuit with other electrical devices. Select an appropriate power supply cable cross-section and use a circuit breaker with a suitable load value and a 30 mA residual current circuit breaker.
7. The device must be installed and grounded with an appropriate grounding conductor. Do not connect the grounding conductor to a gas pipe, water pipe, or lightning rod. In the absence of suitable grounding in the building, it is recommended to establish independent grounding at the device.
8. Do not disconnect the power while the device is in operation.
9. If the device is not used for an extended period, disconnect the main power switch to prevent accidents.
10. If the ambient temperature drops below 0°C, it is prohibited to disconnect the power. If the power is unexpectedly interrupted under such conditions, and the interruption duration is longer than 15 minutes, and no other anti-freezing devices are installed, drain the water from the device and pipes.

ATTENTION!

1. Do not insert hands or other objects into the device's exhaust vent. Otherwise, the high-speed fan may cause bodily harm or damage.
2. Do not remove the fan cover. Otherwise, the high-speed fan may cause injuries to you or others.
3. Lightning and other sources of electromagnetic radiation can have a significant impact on the device.
4. Ensure that the system is filled with water or glycol at the appropriate pressure. Otherwise, the machine may be damaged.
5. The device's operating parameters and set values of protective settings have been selected by the manufacturer. Users should not arbitrarily change the set values or bypass protective settings. Otherwise, the machine may be damaged due to inadequate protection.
6. Please perform regular maintenance of the device as per the instructions to ensure optimal working conditions.
7. In case of unusual symptoms (burning smell), immediately disconnect the power using the switch, stop the device's operation, and contact an Authorized Service Partner or the manufacturer's service. If the abnormal operation continues, it may result in electric shock or fire.
8. Transfer and reinstallation of the unit should be entrusted to an authorized installer.
9. Never make independent modifications, as this can lead to electric shock or fire.
10. If repairs are necessary, please entrust them to an Authorized Service Partner or the manufacturer's service.
11. Do not install the unit in an area where the leakage of easily flammable gases is possible. In the event of a flammable gas leak, a fire may occur around the device.
12. Check if a 30 mA residual current circuit breaker is installed. The absence of such a circuit breaker can lead to electric shock or fire.
13. When cleaning the unit, turn off the power and disconnect the power switch.

2.2. PRECAUTIONS REGARDING REFRIGERANT

1. Do not use methods other than those recommended by the manufacturer to expedite the defrosting or cleaning process.
2. The device should be stored in a room without active potential sources of ignition (such as open flames, operating gas appliances, operating electric heaters).
3. Using open flames near a device filled with refrigerant is prohibited.
4. Keep in mind that refrigerants may not emit an odor.
5. The device should be installed and operated outside the building. In the case of indoor installation, it should be noted that a propane heat pump should be stored in a room that meets safety requirements and is well-ventilated.
6. Rooms containing refrigerant must comply with national gas regulations.
7. Servicing the device should be carried out in accordance with the manufacturer's recommendations.
8. All safety-affecting work procedures should only be carried out by an Authorized Service Partner or the manufacturer's service.

2.3. REQUIREMENTS FOR FLAMMABLE REFRIGERANT

1. Transport of devices containing flammable refrigerants: Compliance with transport regulations.
2. Labeling of devices with signs: Compliance with national regulations.
3. Disposal of devices using flammable refrigerants: Compliance with national regulations.
4. Storage of devices: Devices should be stored in accordance with the manufacturer's instructions.
5. Storage of packaged (unsold) devices: The packaging's protection should be such that mechanical damage to the device inside the packaging does not result in refrigerant leakage. The maximum number of devices that can be stored together is determined by national regulations.

6. Service Information:

- **Area inspection.** Before starting work on systems containing flammable refrigerants, safety checks are necessary to minimize the risk of ignition. When repairing a cooling system, the following safety guidelines should be observed before working on the system.
- **Work procedure.** Work should be carried out following a controlled procedure to minimize the risk of the presence of flammable gas or vapor during work.
- **General work area.** All service personnel and others working in the local area should be informed of the nature of the work being performed. Avoid working in confined spaces. The area around the work location should be secured. Ensure that the conditions in the area have been secured by controlling flammable materials.
- **Checking for refrigerant presence.** The area should be checked with the appropriate refrigerant detector before and during work so that the person performing the operation is aware of potentially flammable atmospheres. Ensure that the leak detection equipment used is suitable for use with flammable refrigerants, i.e., does not spark, is adequately sealed, or is intrinsically safe.
- **Fire extinguisher.** If any „hot work” is foreseen on refrigeration equipment or any associated part, appropriate firefighting equipment should be on hand. In the area where the heating agent is replenished, there should be a powder or CO2 fire extinguisher.
- **No ignition sources.** Any person carrying out work on the cooling system that involves exposing any pipe containing or having contained a flammable refrigerant in the past should not use any ignition sources in a way that could lead to a fire or explosion. All possible ignition sources, including smoking, should be kept at a sufficient distance from the installation, repair, disassembly, and disposal during which a flammable refrigerant may be released into the surrounding space. „No Smoking” signs should be posted before starting work.
- **Ventilated area.** Ensure that the location is outdoors or adequately ventilated before opening the system or starting any „hot work.” Ventilation should be maintained throughout the period when work is being carried out. The ventilation should safely disperse any released refrigerant and, preferably, exhaust it into the atmosphere.
- **Inspection of cooling equipment.** During the exchange of electrical components, they must be appropriate for the purpose and meet the relevant specifications. At all times, manufacturer guidelines for maintenance and service should be followed. If in doubt, consult the manufacturer’s technical department. The following checks should be carried out in installations using flammable refrigerants:
 - a) Machines and ventilation outlets operate correctly and are not blocked;
 - b) If an indirect cooling circuit is used, the presence of refrigerant in the secondary circuit should be checked;
 - c) Equipment labeling or markings are still visible and legible. Markings and signs that are illegible should be corrected;
 - d) Refrigeration pipes or components are installed in a location where the likelihood of exposure to substances that can corrode components containing refrigerant is low, unless the components are made of materials that are naturally corrosion-resistant or are adequately protected from corrosion.
- **Electrical equipment inspection.** Repairs and maintenance of electrical components should include initial safety checks and component inspection procedures. If there is a fault that could pose a safety hazard, no electrical power should be connected to the circuit until the fault has been rectified. If the fault cannot be rectified immediately but it is necessary to continue operations, appropriate temporary solutions should be applied. This should be reported to the equipment owner to ensure that all interested parties are informed. Initial safety checks should include:
 - a) Discharge of the capacitor - this should be done safely to avoid the possibility of sparking;
 - b) Continuity of grounding.

7. Repair of sealed components:

- During the repair of sealed components, all power sources should be disconnected from the device being worked on before removing sealed covers, etc. If it is absolutely necessary to power the equipment during servicing, then a permanent leak detection system should be located at the most critical point to warn of a potentially hazardous situation.
- Special attention should be paid to the following to ensure that working on electrical components does not alter the housing in a way that affects the level of protection. This includes: cable damage, excessive number of connections, use of clamps that do not meet original specifications, seal damage, improper installation of seals, etc.
- Make sure the device is securely mounted. Check if the seals or sealing materials have degraded, which no longer serve their role in preventing the formation of flammable atmospheres. Replacement parts should comply with the manufacturer’s requirements.

NOTE: The use of silicone sealant can reduce the effectiveness of some types of seals.

8. Repair of explosion-proof components.

Do not connect constant inductive or capacitive loads to the circuit without ensuring that it will not exceed the allowable voltage and current for the equipment used. Explosion-proof components are the only types that can be worked on in the presence of a flammable atmosphere. Parts should only be replaced with those specified by the manufacturer. Using other parts may result in ignition of the refrigerant in the atmosphere due to a leak.

9. Cables.

Check that cables are not exposed to wear, corrosion, excessive load, vibrations, sharp edges, or other adverse environmental factors. When checking, also consider the effects of aging or continuous vibrations from sources such as compressors or fans.

10. Detection of flammable refrigerants.

Under no circumstances should potential ignition sources be used to search for or detect refrigerant leaks. Do not use a halogen torch or another detector using an open flame.

11. Leak detection methods.

The following leak detection methods are considered acceptable for systems containing flammable refrigerants.

- a) Electronic leak detectors should be used to detect flammable refrigerants, but their sensitivity may be insufficient or may require recalibration.
- b) Leak detection equipment should be calibrated in an area free of refrigerants.
- c) Make sure the detector is not a potential ignition source and is suitable for the refrigerant used.
- d) Leak detection equipment should be set to the percentage of the Lower Flammable Limit (LFL) of the refrigerant and should be calibrated to the refrigerant used, and an appropriate percentage of gas (up to 25%) should be confirmed.
- e) Leak detection fluids are suitable for use with most refrigerants, but detergents containing chlorine should be avoided as chlorine can react with the refrigerant and corrode copper pipes. .

12. Removal and evacuation.

When dismantling a cooling system for repair or any other purpose, standard safety procedures should be followed, and the following procedure should be observed:

- a) Removal of the refrigerant;
- b) Circuit cleaning using inert gas;
- c) Evacuation;
- d) Recleaning the circuit with inert gas;
- e) Opening the circuit by cutting or soldering.

The refrigerant charge should be recovered into appropriate recovery tanks. The system should be „flushed” with clean nitrogen (OFN) to ensure unit safety. This process may require repetition several times. Do not use compressed air or oxygen for this task. Flushing should involve breaking the vacuum in the system using clean nitrogen (OFN) and continuing filling to reach working pressure, then venting to the atmosphere, and finally re-evacuating to vacuum. This process should be repeated until no refrigerant is inside the system. After using the last OFN charge, the system should be vented to atmospheric pressure to allow work to be carried out. This operation is absolutely necessary if soldering work is to be carried out on the pipeline. Make sure the vacuum pump outlet is not near any ignition sources and ventilation is available.

13. Refilling the Heating Agent Procedures.

In addition to conventional filling procedures, the following requirements must be adhered to:

- Ensure that there is no contamination by different refrigerants during the use of the filling equipment.
- Hoses should be as short as possible to minimize the amount of refrigerant contained in them.
- Cylinders should be kept in an upright position.
- Before filling the cooling system with refrigerant, make sure that the cooling system is grounded.
- Label the system after filling (if not already done).
- Special care should be taken not to overload the cooling system.
- Before filling the system, it should be pressure tested with pure nitrogen (OFN).
- After filling is completed, the system should undergo a leak detection test before being put into operation.
- A subsequent leak detection test should be performed before leaving the work area.

14. Deactivation.

Before proceeding with this procedure, it is essential that the person performing the task has the appropriate qualifications.

It is recommended that all refrigerants be safely recovered. Before starting the task, take a sample of oil and refrigerant in case an analysis is required before reusing the recovered refrigerant. It is essential that electricity is available before starting the task.

- a) Familiarize yourself with the device and its operation.
- b) Disconnect the power supply.
- c) Before attempting the procedure, make sure that:
 - Mechanical devices are available if needed to handle refrigerant cylinders;
 - All necessary personal protective equipment is available and used correctly;
 - The recovery process is overseen by a competent person;
 - Recovery equipment and tanks meet appropriate standards.
- d) Pump out the refrigerant, if possible.
- e) Make sure the refrigerant recovery cylinder is on a scale before starting recovery.
- f) Start the recovery device and follow the manufacturer’s instructions.
- g) Do not overfill the tank (no more than 80% volume of the liquid refrigerant).

- h) Do not exceed the tank's maximum working pressure, even temporarily.
 - i) Once the tank has been filled correctly and the process is complete, ensure the tank and equipment are promptly removed from the worksite, and all isolation valves on the devices are closed.
 - j) Recovered refrigerant cannot be filled into another cooling system unless it has been purified and tested.
15. Labeling.
Devices should be marked, indicating they have been taken out of use and emptied of the refrigerant. The label should be dated and signed. Make sure the device is labeled to indicate that it contains a flammable refrigerant.
16. Recovery.
When recovering a refrigerant from a system, both for servicing and disposal, it's recommended to safely remove all refrigerants. When transferring refrigerants to tanks, ensure the correct recovery tanks are used. Ensure an adequate number of tanks to store the total refrigerant quantity in the system. All used tanks should be designated for refrigerant recovery and marked as such (e.g., special refrigerant recovery tanks). Tanks should be equipped with safety valves and suitable closures that are operational. Empty recovery tanks should be cleared of air and, if possible, cooled before starting recovery. The refrigerant recovery equipment should be functional, with a full set of user instructions tailored to that equipment and suitable for recovering flammable refrigerants. Additionally, a calibrated working scale should be available. Hoses should be equipped with leak-tight quick couplings and be in good condition. Before using the recovery device, check its technical condition, ensure it has been maintained properly, and all its electrical components are tightly closed to prevent ignition in case of a refrigerant leak. If in doubt, consult the manufacturer. Recovered refrigerant should be returned to the refrigerant supplier in a suitable recovery tank along with the appropriate waste transfer document. Refrigerants should not be mixed in recovery units, especially in tanks. If compressors or compressor oils are to be removed, ensure they have been adequately cleaned of refrigerant to an acceptable level, ensuring that the flammable refrigerant does not remain in the lubricating oil. A dehydration process should be conducted before sending the compressor back to the supplier. Only electric heating of the compressor body should be used to accelerate this process. Safety precautions should be observed when draining oil from the system.

2.4. OTHER SAFETY ASPECTS

As a heat source, the pump uses external air, generating energy to heat your home. This manual is an integral part of the product and must be passed on to the user. Carefully read the warnings and recommendations contained in the manual, as they contain important information regarding safety, use, and maintenance of the installation. This heat pump must be installed exclusively by qualified personnel, in accordance with applicable law and in accordance with the manufacturer's instructions. The startup of this heat pump and any servicing work must be carried out only by an Authorized Service Partner or the manufacturer's service. Incorrect installation of this heat pump can lead to harm to people, animals, or property, and in such cases, the manufacturer will not be held responsible.

Always observe the following precautions:

1. Before installing the device, be sure to read the following WARNING.
2. Always follow the remarks provided here, as they contain crucial elements related to safety.
3. After reading these instructions, be sure to store them in an accessible place.
4. The equipment should have the following identification:



3. DESCRIPTION AND APPLICATION

The THERMATEC PLUS C LINE heat pump with a capacity of 50 kW is a heat pump that uses R290 refrigerant, designed for effective heating of large buildings. It also offers the possibility of connecting devices in a cascade system of up to 16 units, which allows for the creation of an ultra-efficient system with a power of up to 800 kW.

Inverter technology allows a single unit to operate in the ranges of 17.56 – 55.30 kW, which ensures high system efficiency and low operating costs. The PLUS C LINE series heat pumps offer the possibility of individual system adjustment to the needs of the building. Our pumps are perfect for heating various large-area facilities.

4. ADDITIONAL ACCESSORIES

Each unit requires the user to purchase at least the following optional items for normal use.

LP.	ACCESSORY NAME	QUANTITY	PURPOSE
1	Buffer tank	1	Storage of thermal energy that can be utilized during periods of increased heat demand in the building.
2	Heating circuit water pump	1	Distribution of the heating medium in the central heating system.
3	Magnetic dirt separator	1	Filters impurities in the heating water system.
4	Diaphragm tank	1	Protects the hydraulic system and the buffer tank from pressure surges.

In addition to the above materials, it is also required to equip the central heating/domestic hot water C.O. system with additional equipment, such as: pipes of the appropriate diameter, pipe brackets, insulations, fittings, air vents, ball valves, and safety valves. The specifications and quantities of specific equipment are determined based on the actual project situation. Electrical installation tasks and additional electric heating should be entrusted to a qualified electrician with appropriate qualifications and permissions.

WARNING!

1. Supply voltage of the unit: 380-415V/3N~/50Hz.
2. Ambient temperature for use: heating: -25°C to 25°C, cooling: 16°C to 45°C. Operating the unit outside this range may trigger a protective shutdown or malfunction in standby mode. Startup status is normal.
3. Inlet water temperature: the lowest inlet temperature is 5°C, and the highest outlet temperature is 75°C. Always consult with the manufacturer if you are using the device outside this range.
4. **Unit anti-freezing:**
 - when the unit operates in an ambient temperature below 2°C, the unit will automatically enter frost protection mode;
 - in standby mode, the unit's compressor or circulating pump will operate automatically;
 - if the unit remains without power for more than 15 minutes, and the ambient temperature is below 0°C, please drain the water from the water system and ensure that the water in the pipes and the unit's circulating pump is fully drained to prevent freezing of the unit and potential damages.

5. PRINCIPLE OF OPERATION

5.1. PRINCIPLE OF OPERATION OF THE HEAT PUMP

Low-pressure heated refrigerant vapors from the evaporator are sucked in and compressed to form high-temperature, high-pressure vapors by the compressor. The heated vapor is directed to the condenser to exchange heat with water. The refrigerant condenses (an exothermic process) into a saturated or subcooled cooling liquid with high temperature and high pressure. The hot water assembly absorbs the heat released during the refrigerant's condensation in the water, raising the water's temperature. The cooling liquid is throttled and expanded through the expansion valve, becoming a low-temperature, low-pressure cooling liquid. The liquid refrigerant flows into the evaporator, where it absorbs heat from the surrounding air and evaporates into the heated refrigerant vapor under low pressure. According

to the refrigerant cycle below, the water flowing through the condenser is continuously heated, and the water temperature increases, thus facilitating the production of hot water.

5.1. PRINCIPLE OF OPERATION OF THE HEAT PUMP

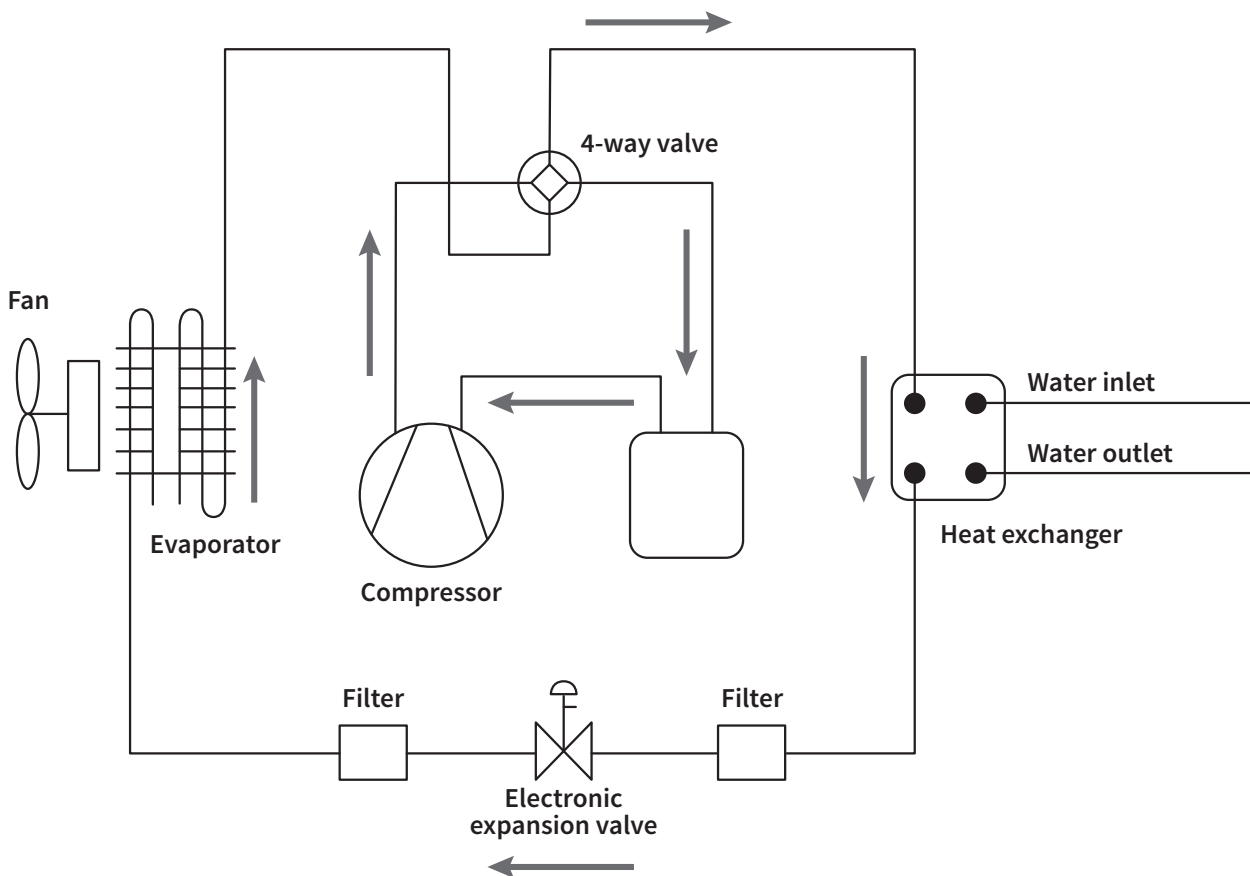
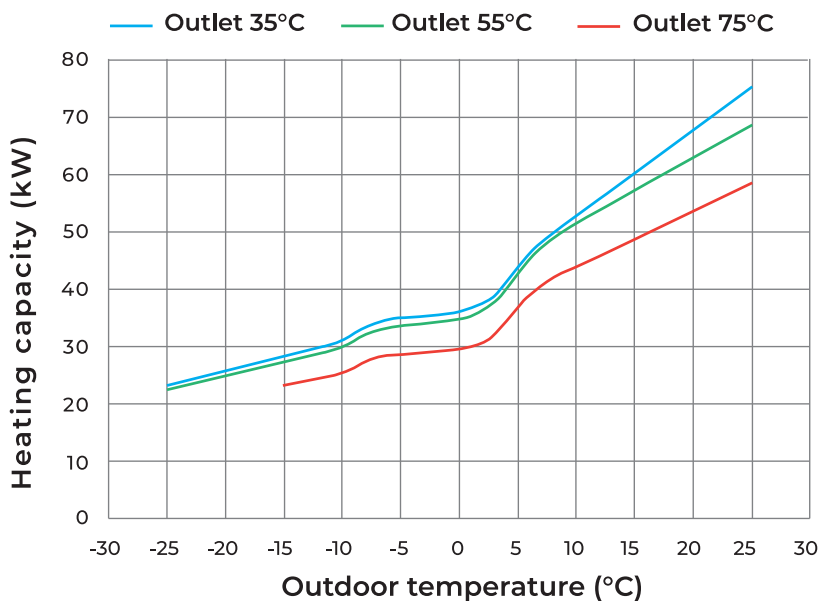

Figure 1. Example diagram of a heat pump operation

5.2. HEATING CAPACITY



6. HEAT PUMP INSTALLATION

6.1. INSTALLATION PRECAUTIONS

Avoid installing the heat pump in places:

- with mineral oil;
- where the air contains more corrosive gases, such as salt and sulfur;
- where there are significant voltage fluctuations;
- with an unstable base or foundation;
- near flammable and explosive materials;
- with strong electromagnetic waves;
- under other adverse environmental conditions.

6.2. INSTALLATION CHECK

- confirm the model, number, name, etc., to avoid incorrect installation;
- check if there is enough space for installation and maintenance;
- ensure the air intake and exhaust are not obstructed;
- check if the weight on the bearing surface meets the requirements;
- verify if the power supply and wire diameter have been chosen in accordance with the electrical installation requirements given the capacity of the heat pump;
- the electrical installation must comply with the relevant technical standards for electrical equipment;
- for extrapolation actions and adjustments, the unit must be connected to the power supply for at least 8 hours.

6.3. INSTALLATION SPACE

During installation, leave the maintenance space shown in the diagram below before installing the device. There should be no obstacles within 2000 mm above the unit, and on the water installation connection side, the minimum distance should be 600 mm. The following illustration shows the obstacle distance in both horizontal and vertical directions (mm).

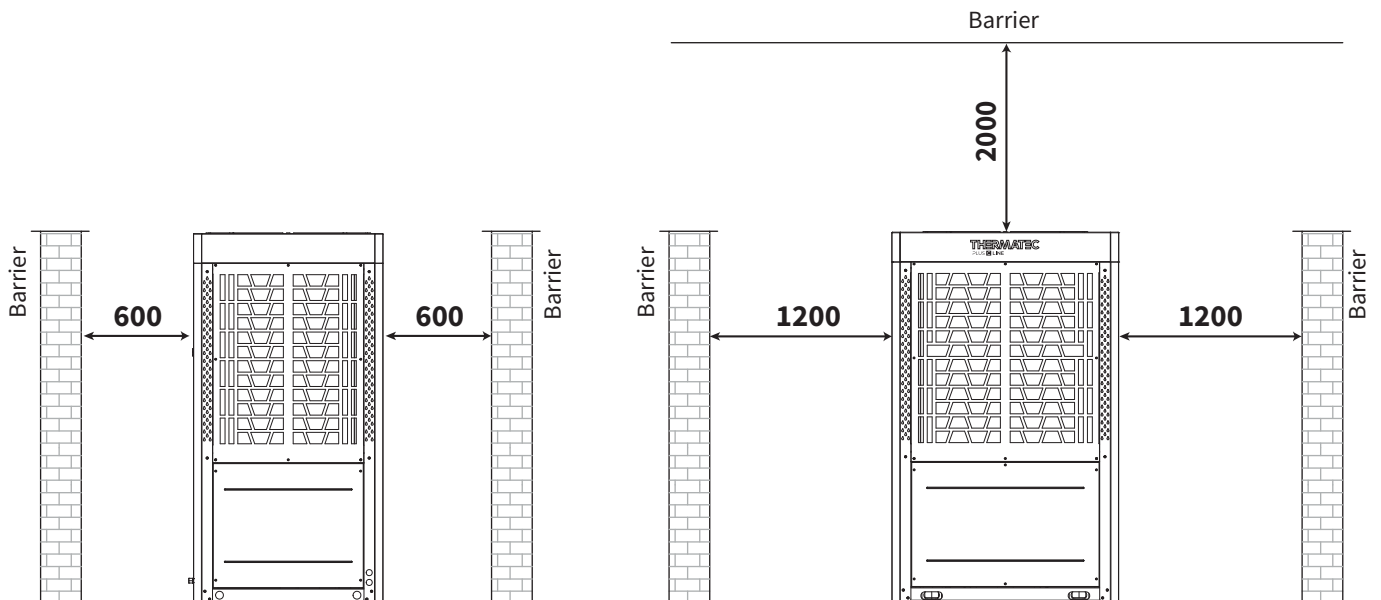

Figure 3. Horizontal and vertical obstacle distance (mm) in the context of heat pumps

6.4. TRANSPORTING THE HEAT PUMP AND PLACEMENT ON THE FOUNDATION

Transporting the device to the planned work location should be conducted with utmost care and attention to safety measures. For offloading over longer distances, the use of appropriate equipment like a forklift is necessary. During the transport, it's crucial to ensure the heat pump doesn't sustain any damages. The unit should always be transported in an upright position.

1. To lift the unit, use more than 4 soft lifting straps (See Figure 6).
2. To avoid scratches and deformation of the device surface, a protective plate should be applied to the surface of the device during lifting and transport.
3. Before the final installation, re-check the foundation to prevent errors in relation to the actual object.
4. During the defrost function, a large amount of condensate is produced. Remember to install a drain or prepare a base for direct condensate discharge.

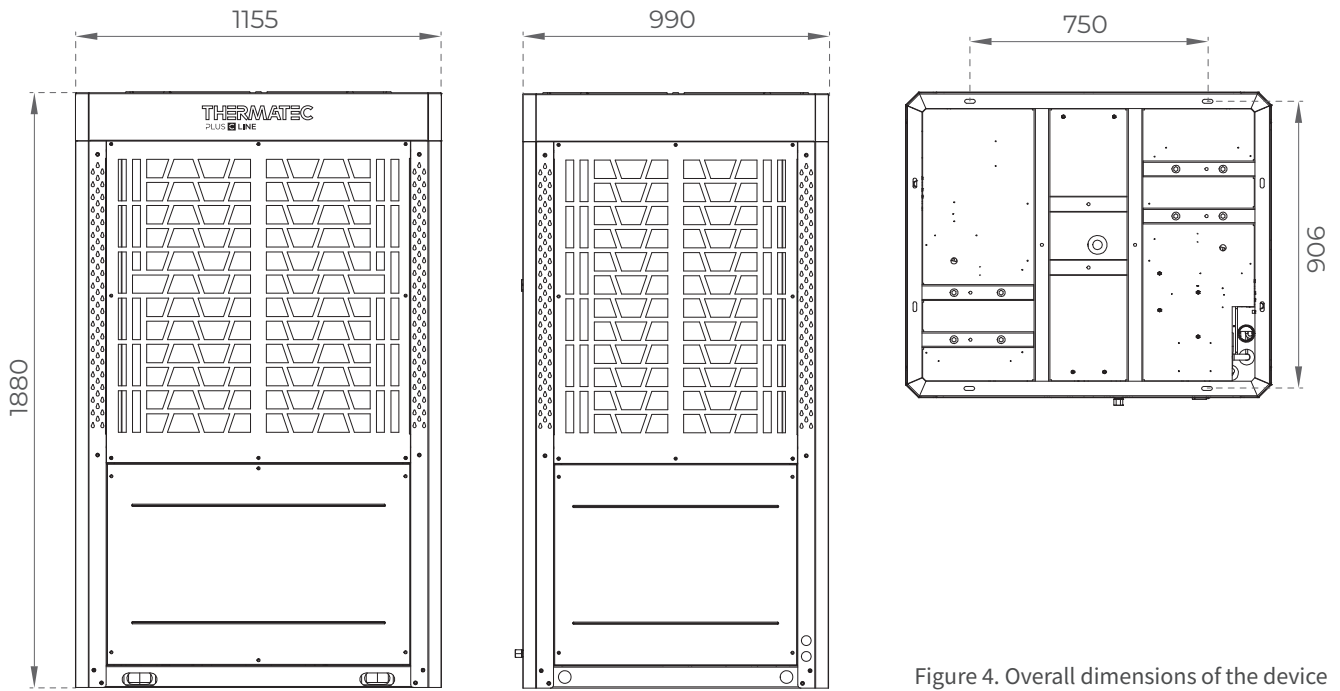

Figure 4. Overall dimensions of the device

MODEL / SIZE (MM)	LENGTH (L)	WIDTH (W)	HEIGHT (H)
TH-R290-C50-3P	1155	990	1880

During installation, each unit should be installed on a foundation according to the outline drawing below (see Figure 5).

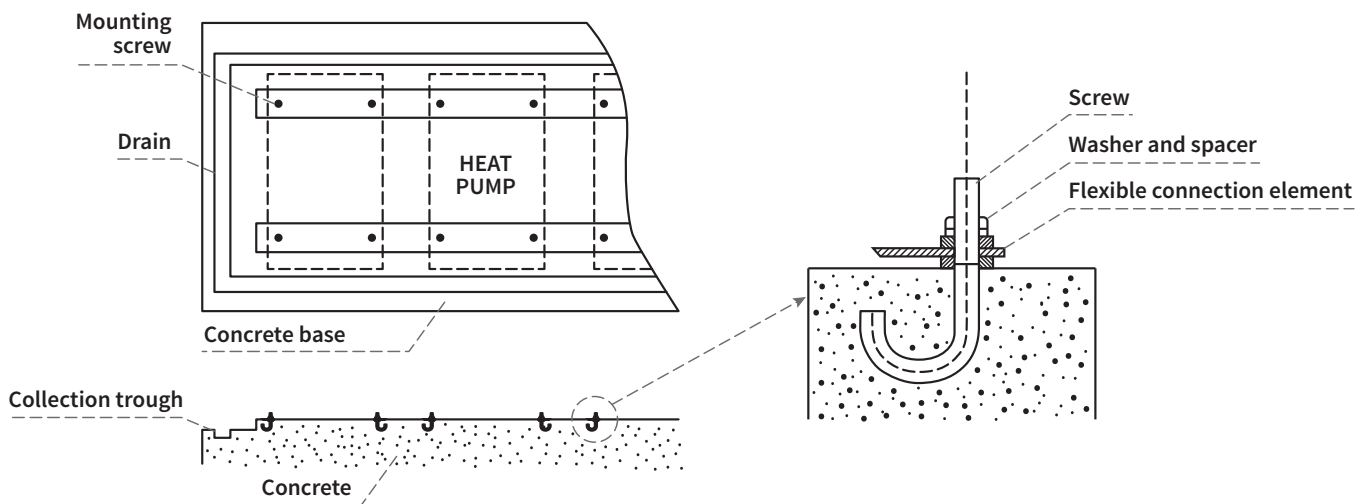

Figure 5. Example foundation diagram

6.5. WATER PIPING INSTALLATION

Installation notes:

- make an effort to prevent dust and other contaminants from entering the piping system;
- the device should be secured before installing water pipes;
- inlet and outlet pipes should be insulated with thermal insulation materials;
- the piping system ensures a specified water flow rate, try to avoid elements that choke the flow;
- do not hook transport straps onto the inlet and outlet pipes during unit transportation. You can only hook them onto the mounting holes of the base beam (See Figure 6);
- when connecting inlet and outlet pipes, use two pipe wrenches to tighten both parts of the pipe (See Figure 7);
- before selecting a circulation pump, calculate the pressure and flow rate in the applied water pipe;
- the pressure drop in a pipe section can be selected in the range of 0.3 to 0.5 kgf/cm², and the flow velocity in the main pipe can be selected in the range of 1.2 ~ 2.5 m/s (see the table below);
- after selecting the main water pipe, hydraulic calculations should be carried out. If the water side pipe resistance is greater than the parameter of the selected water pump, a larger water pump should be chosen or the diameter of the main pipe should be increased.

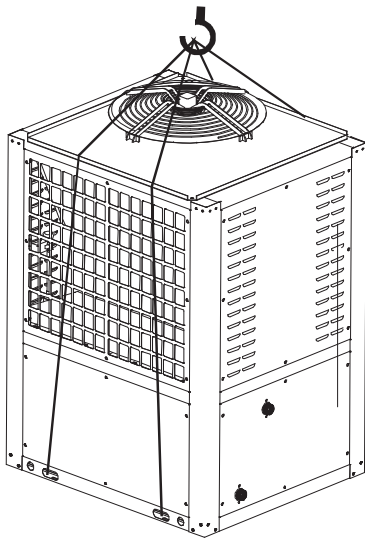

Figure 6. Lifting diagram

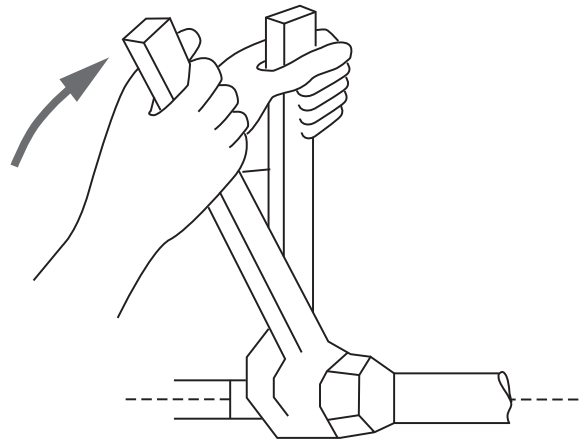
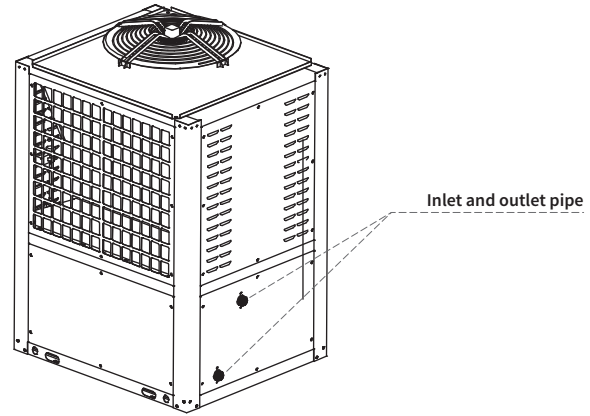

Figure 7. Plumbing installation diagram

WATER FLOW RECOMMENDED VALUE (M/S)				
Pipe diameter (mm)	15	20	25	32
Pressurized system (m/s)	0,4~0,5	0,5~0,6	0,6~0,7	0,7~0,9
Non-pressurized system (m/s)	0,3~0,4	0,4~0,5	0,5~0,6	0,5~0,8
Pipe diameter (mm)	40	50	65	80
Pressurized system (m/s)	0,8~1,0	0,9~1,2	1,1~1,4	1,2~1,6
Non-pressurized system (m/s)	0,7~0,9	0,8~1,0	0,9~1,2	1,1~1,4
Pipe diameter (mm)	100	125	150	200
Pressurized system (m/s)	1,3~1,8	1,5~2,0	1,6~2,2	1,8~2,5
Non-pressurized system (m/s)	1,2~1,6	1,4~1,8	1,5~2,0	1,6~2,3
Pipe diameter (mm)	250	300	350	400
Pressurized system (m/s)	1,8~2,6	1,9~2,6	1,6~2,6	1,8~2,6
Non-pressurized system (m/s)	1,7~2,4	1,7~2,4	1,6~2,1	1,8~2,3

Figure 8. Example placement of the inlet and outlet pipe



6.6. EXAMPLE DIAGRAM OF A GLYCOL/WATER HYDRAULIC INSTALLATION

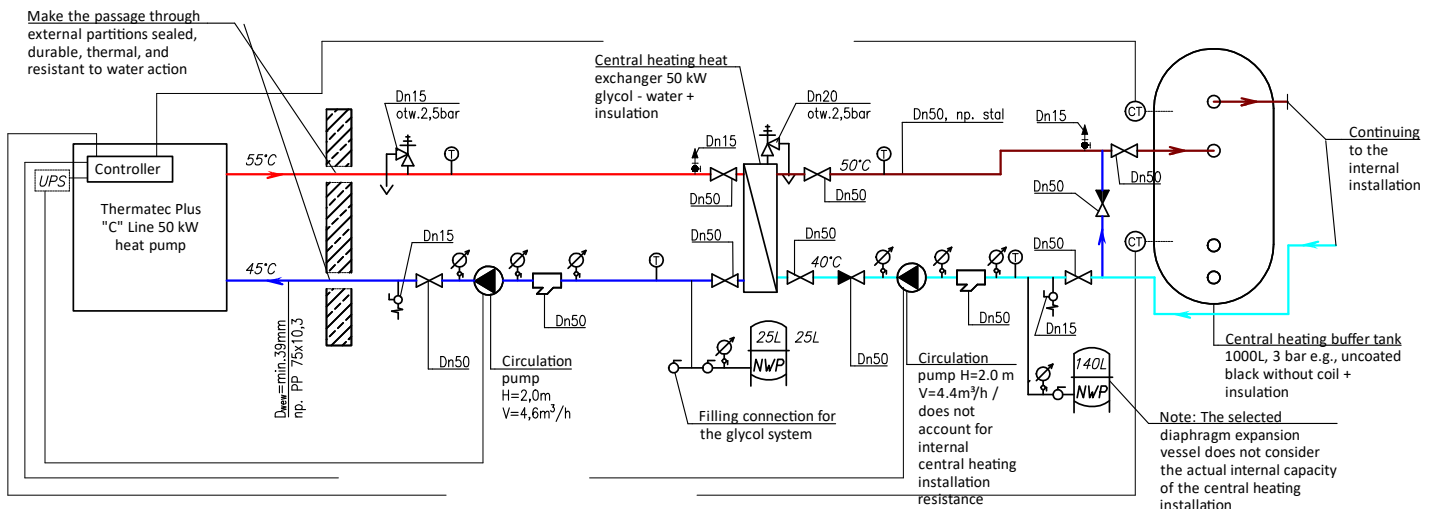

MARKINGS

- Supply } primary heating circuit
- return }
- Supply } secondary heating circuit
- return }
- control signal
- shut-off valve
- drain valve
- safety valve
- mesh filter
- manometr
- thermometer
- diaphragm expansion vessel
- automatic air vent
- temperature sensor 0-120°C
- quick coupling for diaphragm vessel

6.6.1. SELECTION OF THE MAIN PIPE DIAMETER FOR MULTIPLE UNITS CONNECTED IN PARALLEL

Example (recommended value):

- Inlet/outlet: 1 pcs: DN50
- Inlet/outlet: 2 pcs: DN65
- Inlet/outlet: 3 pcs: DN80
- Inlet/outlet: 4 pcs: DN100
- Inlet/outlet: 5 pcs: DN100

6.6.2. WATER QUALITY CHECK

When water quality is poor, more sediments, such as scale and sand, form. To counteract this, the water should be filtered and softened before filling the water system. Before using the device, analyze the water quality, for instance, its PH value, conductivity, chloride ion concentration, sulfate ion concentration, etc. The following presents water quality standards applicable to this device:

PH	Hardness	Electrical Conductivity	S (Sulfur)	Cl (Chlorine)	NH ₃ (Ammonia)
7~8,5	< 50 ppm	< 200 μS/cm (25°C)	lack	< 50 ppm	lack
SO ₄ (Sulfate)	Si (Silicon)	Fe (Iron)	Na (Sodium)	Ca (Calcium)	
< 50 ppm	< 30 ppm	< 0,3 ppm	lack	< 50 ppm	

7. PARAMETRY TECHNICZNE POMPY CIEPŁA

MODEL		TH-R290-C50-3P	
Power supply			380-415V/3N~/50Hz
Input power		kW	48.17
Heating (A7/W35)	heating capacity range	kW	17.56 – 55.30
	input power	kW	3.15 – 14.85
	COP	kW/kW	3.72 – 5.57
Heating (A7/W55)	heating capacity range	kW	17.95 – 51.20
	input power	kW	5.42 – 19.20
	COP	kW/kW	2.67 – 3.31
Cooling (A35/W12)	cooling capacity range	kW	10.00 – 32.00
	input power	kW	3.84 – 13.30
SCOP average (THW* at 35°C)		kWh/kWh	3.92
SCOP average (THW* at 55°C)		kWh/kWh	3.25
Rated input power		kW	19.84
Rated input current		A	30.3
Refrigerant TYPE / CHARGE / GWP		- / kg /-	R290 / 2 x 2.5 / 3
CO ₂ equivalent		TCO ₂ eq	0.015
Operation pressure (low side)		MPa	0.8
Operation pressure (high side)		MPa	3.0
Maximum allowable pressure		MPa	3.0
Electrical shockproof		Klasa	I
Ingress protection		IP	IPX4
Maximum outlet water temperature		°C	75
Operating ambient temperature		°C	-25 ~ 45
Water piping connections		cal	G1 1/2
Rated water flow		m ³ /h	8.6
Water pressure drop		kPa	6.5
Water pressure (min. – max.)		MPa	0.1 – 0.3
Sound pressure (1 m)		dB(A)	60
Net dimensions (L x W x H)		mm	1155 x 990 x 1880
Net weight		kg	500

NOMINAL TEST CONDITIONS

Heating (A7/W35): Outdoor temperature 7°C/6°C (DB/WB) Water inlet/outlet 30°C/35°C
 Heating (A7/W55): Outdoor temperature 7°C/6°C (DB/WB) Water inlet/outlet 47°C/55°C
 Cooling (A35/W12): Outdoor temperature 35°C/24°C (DB/WB) Water inlet/outlet 12°C/7°C

*THW - water outlet temperature

8. ELECTRICAL CONNECTION

The heat pump should be connected through an electrical panel that allows for the safe disconnection of the pump's power supply. The electrical panel for powering a single heat pump should be equipped with a 40A/32mA residual-current device and an 32A overcurrent breaker for the heat pump's power supply.



All electrical installation connection tasks should be entrusted to a qualified electrician with the appropriate qualifications and permissions.

For powering a single heat pump, a 3-phase 400V~ supply cable with a minimum conductor cross-section of 5 x 4 mm² should be provided. When connecting the power supply, attention must be paid to maintaining the correct phase alignment with the heat pump. In the event of an incorrect connection, starting the system could lead to an error occurrence or damage to the heat pump. It is recommended that the cables be routed using electrical conduits and protective grommets. The location for the 400V~ power connection is shown in the drawing below.

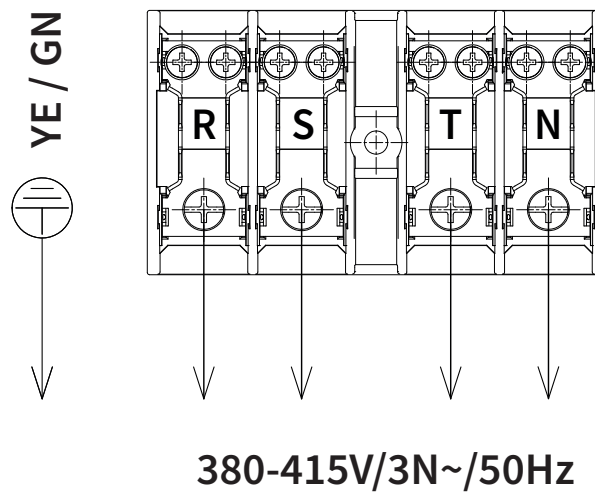

Before starting the heat pump, it is necessary to check all connections of metal components and protective PE conductors to the potential equalization busbar and the main grounding busbar of the building and/or the ground electrode.

8.1. CONTROL

Control of the individual electrical components that are part of the heat pump equipment is carried out via a touch controller and electrical signals from the heat pump. The pump is equipped with a water temperature sensor in the buffer tank (symbol T8), which should be installed in the upper part of the buffer tank.

Control of the circulation pump is carried out via the heat pump controller after connecting the wires to the appropriate terminals on the control strip in accordance with the diagram. Pay attention to the voltage terminals. Voltage of 230V~ is applied to terminals 3, 4, 5, 7 relative to the N potential (terminal 6) after activation.

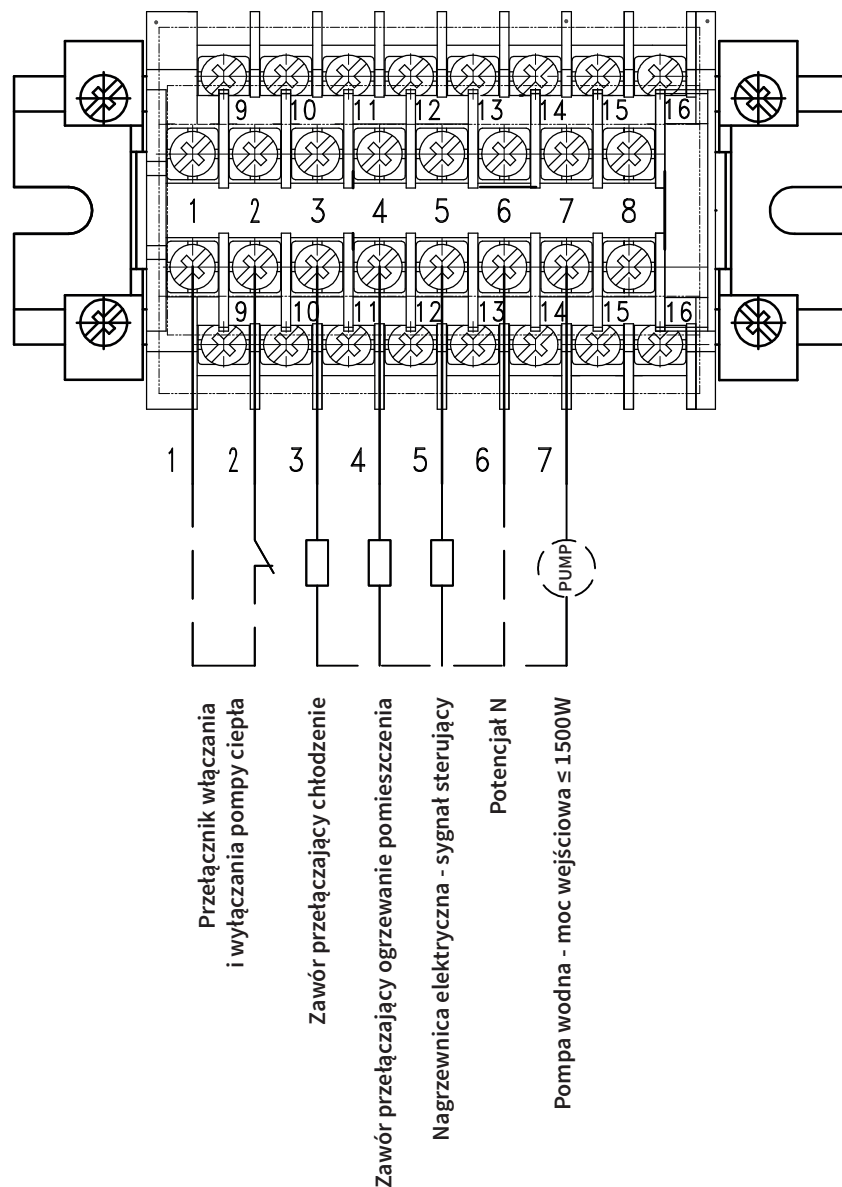

8.2. PREPARATION OF THE SYSTEM FOR STARTUP

The initial startup and heating phase must be carried out by a qualified and authorized specialist, such as an Authorized Service Partner. Before the system is started for the first time, it should be filled with treated heating water (according to requirements).

The following points should be checked before starting up:

- Before commencing work, the power supply to the heat pump should be disconnected at the circuit breaker.
- All hydraulic connections must be installed and leak-free.
- All valves in the heating circuit must be open. Partially closed valves could adversely affect the proper flow of heating water.
- All settings of the heat pump controller should be adjusted to the heating installation as per the instructions.
- The heating water circuit and buffer tank must be fully filled and purged of air.
- Purging of the heating installation - ensure that all heating circuits are open, purge the system at the highest point, and if needed, top up the water (maintain minimal static pressure).
- Check the insulation condition and correctness of electrical connections. It's important that they are properly protected and routed to prevent contact with liquid during filling and system operation.

After completing the heating process, the set temperature value and actual temperature should show approximate values. If the water in the buffer tank is being heated, there will be a change in the tank's volume.

9. USAGE



The installer should inform the user about the functions of the heat pump and provide necessary information for its safe usage. Before starting operation, it is important to read and understand this manual thoroughly, as well as the instructions of other applied devices, and adhere to the guidelines provided.



ATTENTION

The use of the heat pump should not be entrusted to children or individuals with limited physical, sensory, or intellectual abilities, or to individuals without the required experience and knowledge, unless they are supervised or instructed on how to use the device by a person responsible for their safety. The device should be stored out of the reach of children.

Before starting to use the heat pump, it is necessary to inspect the overall technical condition of the unit.

Please check if:

1. All pipe connections are tight and not leaking.
2. Safety valves are unobstructed and undamaged.
3. The heat pump is standing on the floor stably, vertically, and has been leveled and securely fastened to the substrate.
4. All connections with fittings of the buffer tank are made of appropriate material.



ATTENTION

Failure to comply with the above information will result in the loss of warranty. In case of any irregularities, please report this to the Authorized Service Partner or the manufacturer's service.

10. INSPECTION AND MAINTENANCE

External parts can be cleaned using a damp cloth and commonly available cleaning agents. Do not use any caustic cleaners or thinners to clean the device. In hospitals and other public utility buildings, adhere to the applicable regulations regarding cleaning and disinfection.

If there is a risk of freezing during the shutdown of the heat pump, it is also important to consider that the risk of freezing extends not only to the water in the buffer tank but also to the water in all pipes leading to the radiators. Therefore, it is recommended to drain all fittings and pipes supplying water in the heating circuits.

10.1. MAINTENANCE

- During the inspection of control and protective devices, adjustments to the setpoint should not be made without justification. Pay special attention to whether various operational parameters of the system are within normal range during operation.
- Regularly check if the terminals of the electrical wiring are loose; if they are, tighten the terminal screws.
- Regularly inspect the condition of electrical components and promptly replace any damaged elements.
- After prolonged operation, calcium oxide or other minerals may deposit on the surface of the copper tubing in the heat exchanger. Deposits on the heat exchange surface will affect the efficiency of heat exchange and lead to increased energy consumption and higher refrigerant pressure. As the pressure drops, the amount of hot water to the unit decreases. The heat exchanger can be cleaned with organic acids such as formic acid, citric acid, and acetic acid.
- Dust from the fins of the evaporator should be blown off regularly (usually once a month) using compressed air with a pressure greater than 0.6 MPa, brushed with a specially designed metal comb, or flushed with pressurized water. If there is excessive dirt, use a brush with a strong detergent to clean it.
- After a longer period of inactivity, when starting the device, perform the following preparatory actions: thoroughly inspect and clean the device, clean the water installation, check the water pump, and tighten all pipe connections.
- Use original manufacturer's parts for repairs, and avoid using similar parts from other companies.

10.2. LEAK DETECTION AND PRESSURE TESTING

During leak detection and pressure testing, never fill the cooling system with oxygen, acetylene, or other flammable and toxic gases. Only compressed air, nitrogen, or refrigerants should be used for such tests.

10.3. DISMANTLING THE COMPRESSOR

Perform the following steps:

- Turn off the electrical power at the main device switch;
- Discharge the refrigerant from the system into a low-pressure side tank, ensuring a gradual release to prevent refrigerant oil leakage;
- Dismantle the compressor suction and discharge pipes;
- Disconnect the power cable from the compressor;
- Unscrew the mounting screws of the compressor;
- Take out the compressor.



ATTENTION

Perform regular maintenance of the device to ensure its proper operation.

11. ERROR CODES

ERROR CODE	ERROR DESCRIPTION	POSSIBLE CAUSES OF FAILURE AND THEIR DIAGNOSTIC METHODS
E01	Phase sequence error	Check phase sequence / reset the machine
E02	Phase failure	Check voltage on phases / reset the machine
E03	Flow error	Circulation pump failure or blockage of the water system
E05	High voltage error	<ul style="list-style-type: none">• Occurrence of high voltage three times will display an error• Check the electrical connection
E06	Low voltage error	<ul style="list-style-type: none">• Three occurrences of low voltage will display an error• Check the electrical connection
E09	Communication error	Communication error between the main board and the inverter's main board
E10	Water flow failure in the heat pump	Blockage of the water system
E11	Operating time protection	Turn off the device for protection
E12	Compressor discharge temperature too high	<ul style="list-style-type: none">• Three occurrences of too high temperature at the compressor will display an error• Check if the device has the appropriate amount of refrigerant and check the water flow in the system
E15	Water inlet temperature sensor failure	<ul style="list-style-type: none">• Damaged main board• Damaged sensor

ERROR CODE	ERROR DESCRIPTION	POSSIBLE CAUSES OF FAILURE AND THEIR DIAGNOSTIC METHODS
E16	Plate heat exchanger temperature sensor failure	<ul style="list-style-type: none"> • Damaged main board • Damaged sensor
E18	Compressor temperature sensor failure	<ul style="list-style-type: none"> • Damaged main board • Damaged sensor
E20	Internal temperature sensor failure	<ul style="list-style-type: none"> • Damaged main board • Damaged sensor
E21	Ambient temperature sensor failure	<ul style="list-style-type: none"> • Damaged main board • Damaged sensor
E23	Freeze protection	Anti-freeze mode
E25	Water flow sensor failure	<ul style="list-style-type: none"> • Automatic error reset • Sensor damage • Contamination of the installation
E27	Water supply temperature sensor failure	<ul style="list-style-type: none"> • Damaged main board • Damaged sensor
E29	Compressor suction temperature sensor failure	<ul style="list-style-type: none"> • Damaged main board • Damaged sensor
E32	Protection against excessive refrigerant temperature	Check the cooling and heating system
E35	Too high power consumption	Check the electrical connections
E44	Protection against low ambient temperature	Automatic error clearing
E45	Protection against overheating of the drip tray heater	Automatic error clearing
E46	Protection against overheating of the additional water system heater	Automatic error clearing

12. TROUBLESHOOTING

FAILURE	POSSIBLE CAUSES	METHODS OF DETECTION AND EXCLUSION
High exhaust pressure	<ol style="list-style-type: none"> 1. Air or another non-condensable gas is present in the water system 2. Possible scaling / contamination of the water side of the heat exchanger 3. Insufficient water flow 4. Excess refrigerant 	<ol style="list-style-type: none"> 1. Remove air from the water heat exchanger 2. Clean the water side of the heat exchanger 3. Check the water installation pipelines and pumps 4. Replace and weigh the appropriate amount of refrigerant
Low exhaust pressure	<ol style="list-style-type: none"> 1. Insufficient amount of refrigerant 2. Low suction pressure 3. Liquid refrigerant is entering the compressor directly from the evaporator 	<ol style="list-style-type: none"> 1. Refill with refrigerant 2. Low suction pressure 3. Inspect the evaporator for contamination
High suction pressure	<ol style="list-style-type: none"> 1. Excess refrigerant 2. Damage to the 4-way valve 3. Poor compressor compression 4. Liquid refrigerant flowing into the compressor from the evaporator 	<ol style="list-style-type: none"> 1. Replace and weigh the appropriate amount of refrigerant 2. Replacement of the 4-way valve 3. Compressor replacement
Low suction pressure	<ol style="list-style-type: none"> 1. Insufficient amount of refrigerant 2. Expansion valve failure 3. Damage to the 4-way valve 4. Refrigerant leak from the system 	<ol style="list-style-type: none"> 1. Refill with refrigerant 2. Replace the expansion valve 3. Replace the 4-way valve 4. Check for leaks and refill refrigerant
High compressor pressure	<ol style="list-style-type: none"> 1. The discharge pressure of the compressor is too high 2. The set water temperature of the device exceeds the allowable value 3. Damaged high-pressure sensor 	<ol style="list-style-type: none"> 1. High pressure on charge 2. The set water temperature of the device is adjusted to the allowable value 3. Replacement of high-pressure sensors
Compressor protection against current overload	<ol style="list-style-type: none"> 1. The discharge pressure of the compressor is too high 2. Insufficient or excessive supply voltage 3. Damage to the current transformer 4. Damaged compressor motor or short circuit of terminals 5. Error in setting the motor current protection value 	<ol style="list-style-type: none"> 1. High pressure on charge 2. Voltage should not exceed or be lower than the nominal voltage for 15 operating cycles 3. Replacement of current transformers 4. Compressor replacement 5. Adjust the current to the set protection value
Compressor shutdown due to the operation of the built-in temperature regulator	<ol style="list-style-type: none"> 1. Too high / low compressor motor supply current 2. Excessive charge pressure leads to compressor motor overload 3. Insufficient amount of refrigerant 	<ol style="list-style-type: none"> 1. The voltage should not exceed or be less than 15% of the nominal voltage 2. High charge pressure 3. Low suction pressure
Compressor shutdown to protect against low pressure	<ol style="list-style-type: none"> 1. Filter clogging 2. Blockage or failure of the expansion valve 3. Suction pressure in the system is too low 4. Low pressure sensor failure 	<ol style="list-style-type: none"> 1. Check, repair, or replace filters 2. Check the expansion valve 3. Low suction pressure 4. Check the system pressure and, if necessary, replace the low pressure sensor
Excessive compressor noise	<ol style="list-style-type: none"> 1. Excess liquid refrigerant entering the compressor from the evaporator, causing compressor liquid slugging and increasing noise 2. Contaminants entering the compressor 3. Poor compressor lubrication 	<ol style="list-style-type: none"> 1. Check the system superheat setting and the bypass valve temperature setting, inspect and adjust or replace the expansion valve 2. Replace the compressor 3. Add lubricating oil or replace the compressor
The compressor cannot start	<ol style="list-style-type: none"> 1. The control circuit is not switched on 2. Compressor damage 	<ol style="list-style-type: none"> 1. Check the control system 2. Replace the compressor

13. ELECTRICAL SCHEMATIC

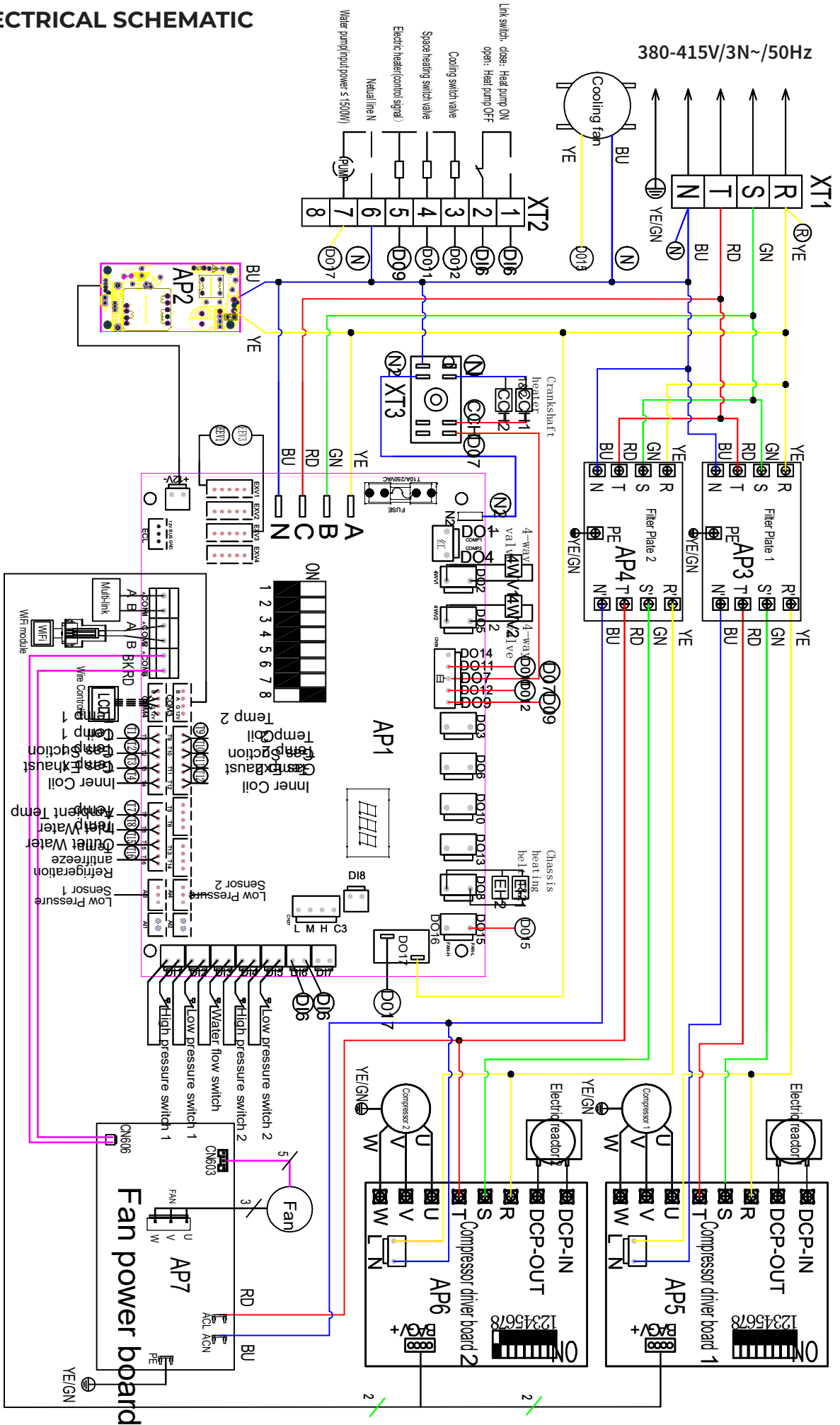

14. TOUCH SCREEN WIRING CONTROLLER MANUAL

14.1. CONNECTING THE WIRED CONTROLLER WITH LCD DISPLAY

After connecting the controller's power supply, select the appropriate language option and click the checkmark , to enter the system. If you do not select a language within 2 minutes, the system will automatically enter the system in the current language.

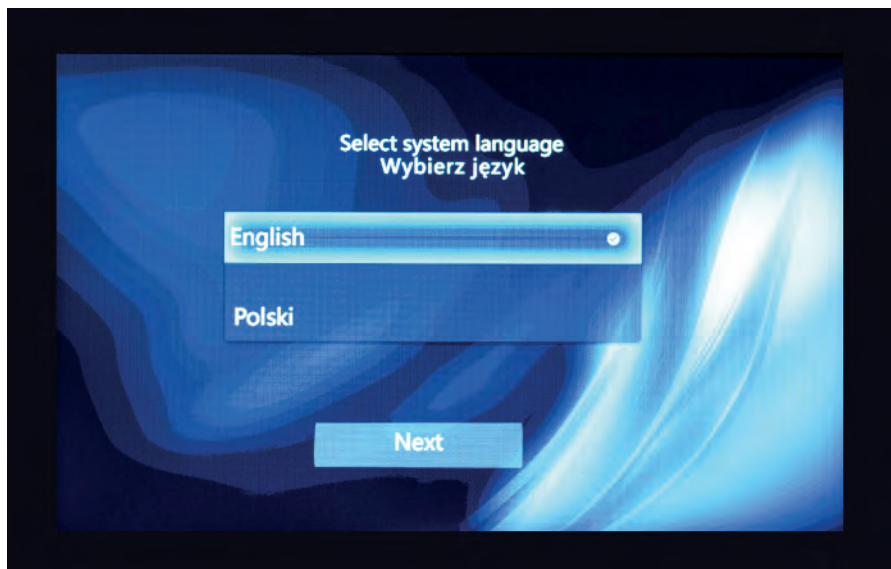

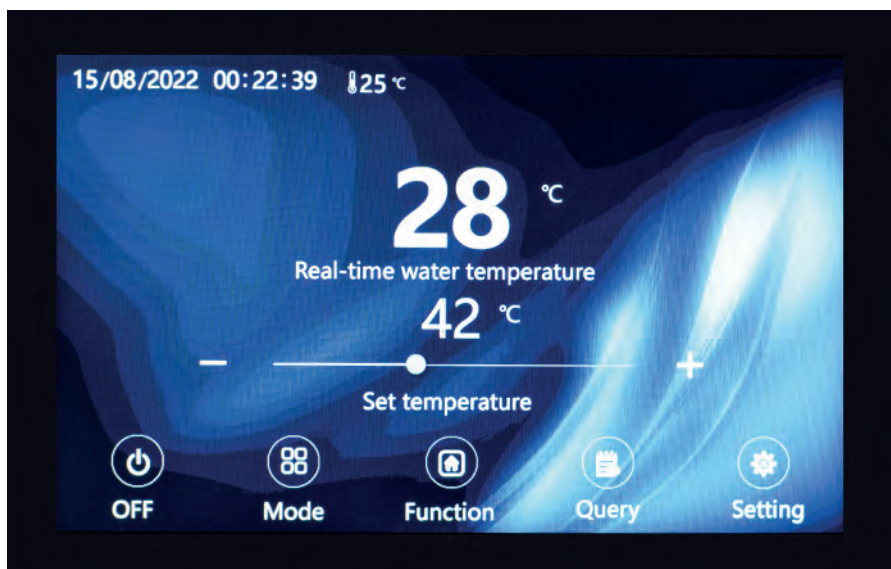

Upon entering the system, the following page is displayed. The page appears after 3 seconds. If communication fails, the display will remain unaffected. The touchscreen is accompanied by key sounds. If the backlit screen is not used for 2 minutes, it will automatically enter sleep mode. Click on the screen to activate it.

14.2. DISPLAYING THE MAIN INTERFACE



On the main interface, from left to right at the top of the main interface, the following elements are visible: date/month/year, time, temperature, defrosting, cascade mode, quiet mode, water pump, water return valve, electric heating, compressor, fan, Wi-Fi. Display mode: In the on state, the current operating mode is displayed to the left of the main interface. The operating mode is not displayed after power is turned off.

Error Display: When a unit malfunction occurs, the icon  will blink. You can click on the icon to view current errors or error records.

Displaying defrosting: When the unit enters defrosting mode, the icon  is always illuminated. Blinking display when refrigerant recovery is in progress.

Cascade mode display: When the unit network is enabled, the icon  is always illuminated.

Quiet mode display: When the unit enters quiet operation mode, the icon  is always illuminated.

Displaying timer mode: When the timer mode function is enabled, the icon  is always illuminated.

Displaying water pump operation: When the water pump is running, the icon  is always illuminated.

Displaying water pump operation: When the water pump is running, the icon  is always illuminated. When the return valve is not activated, set the return water time.

Displaying electric heating operation: When the electric heater is turned on, the icon  is always illuminated.

If the electric heater is not turned on, and the quick heating function is enabled, the icon  will flash more frequently.

If the electric heater is not turned on and the sterilization function is enabled, the icon  will flash less frequently.

Displaying compressor operation: When the compressor is running, the icon  is always illuminated.

Displaying fan motor operation: When the fan is running, the icon  is always illuminated.

Wyświetlanie połączenia Wi-Fi: When the unit successfully connects to the Wi-Fi network, the icon  is always illuminated.

14.3. CONTROL PANEL OPERATION



14.3.1. POWER ON/OFF BUTTON

On the illuminated screen, press the button marked with the symbol , to turn the device on or off. During startup, the text „ON” will appear below the icon, and at the same time, the current operating mode will be displayed in the upper left corner. When the device is turned off, the mode icon will be inactive.

14.3.2. MODE SELECTION BUTTON

On the illuminated screen, press the button  to enter the mode selection page. On the mode selection page, click the appropriate mode to switch between modes. You can also press „Mode” in the upper left corner to go back or „Main” in the upper right corner to return to the main page.



	HEATING
	COOLING
	UNDERFLOOR HEATING

14.3.3. SETTING THE TEMPERATURE



You can click the „+” or „-” button to adjust the set temperature for the current mode. You can also slide the slider to set the desired temperature for the current mode. You can also click „Set Temperature Value,” enter the desired temperature on the displayed keyboard, and then press „Enter” to make the modification.





14.4. QUICK HEATING, QUIET MODE, FORCED DEFROST, SYSTEM BLEEDING, HIGH-TEMPERATURE DOMESTIC HOT WATER STERILIZATION

On the illuminated screen in the main interface, click the upward arrow , to go to the function selection page.

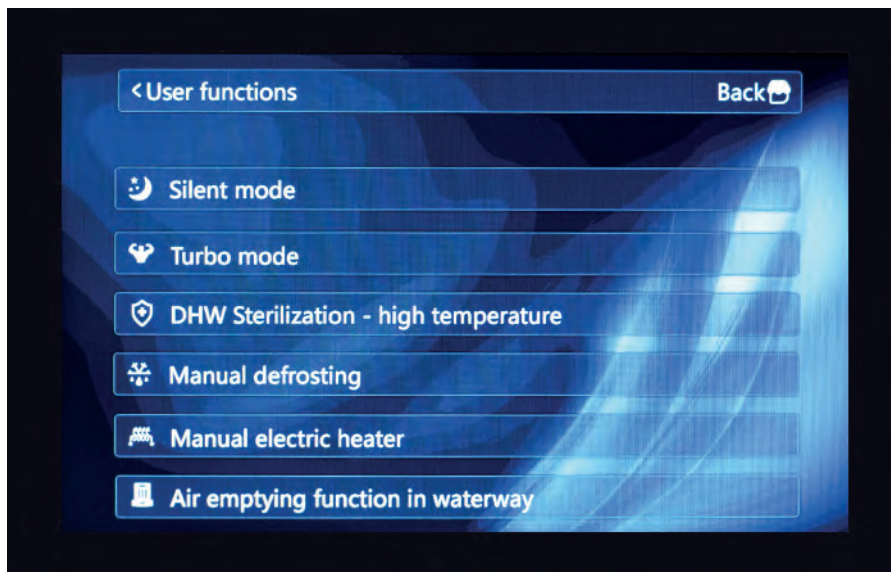
Then click  **User functions**, to enter user operation. From top to bottom, there are modes: quiet mode, strong mode, high-temperature sterilization, forced defrost, manual quick heating, system bleeding. Click the appropriate button to activate/close the respective function.



14.5. FACTORY MODE



On the illuminated screen, click the upward arrow , to go to the function selection page, then click  **Factory Functions**

Type „1122” on the keyboard that appears, press „Enter” to enter the factory mode, and then click **(Inverter test)** to confirm. In factory mode, you will be able to perform various operations related to device configuration and diagnostics. However, be cautious and aware that changes made in factory mode can affect the device’s operation.

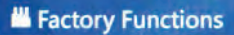
14.6. REFRIGERANT RECOVERY FUNCTION

On the illuminated screen, click the upward arrow , to go to the function selection page, then click , to enter the refrigerant recovery function. A keyboard will appear, where you should enter „1122,“ and then press „Enter“ to enter factory mode. Next, press and hold the **(Refrigerant recovery)** button for at least 3 seconds to initiate the refrigerant recovery process.

14.7. QUERYING DEVICE'S CURRENT OPERATION PARAMETERS

On the illuminated screen, click , to go to the query page, then click , to access the Temperature Status overview. When the network is enabled, press , to select a number. Click the relevant online unit number to query the temperature status for the respective unit. Units with a gray background (not illuminated) are offline.

14.8. PARAMETER SETTINGS

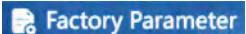
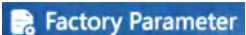
On the illuminated screen, click , to access the settings page, then click , to enter the parameter settings page. When the network is active, press , to select a group number. Click the relevant online unit number to access the parameter settings for the respective unit. Units with a gray background (not illuminated) are offline.

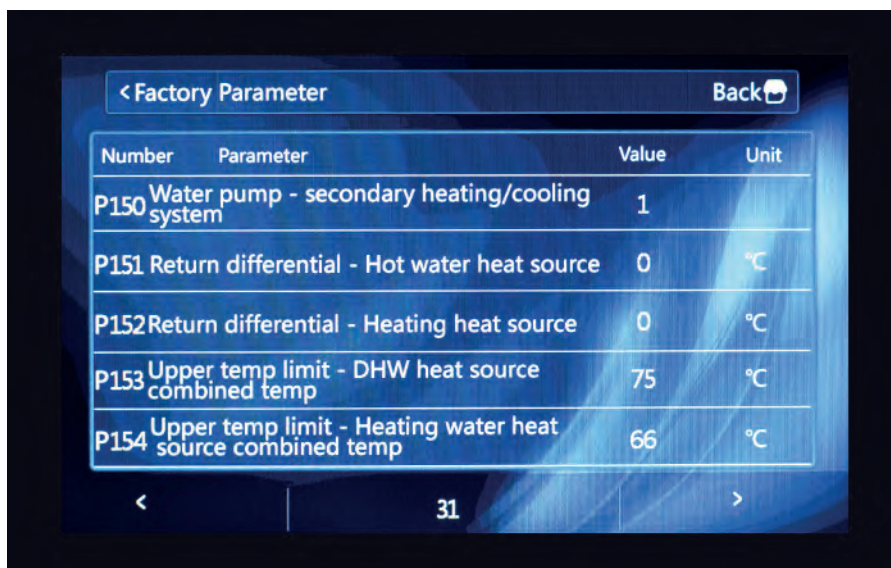
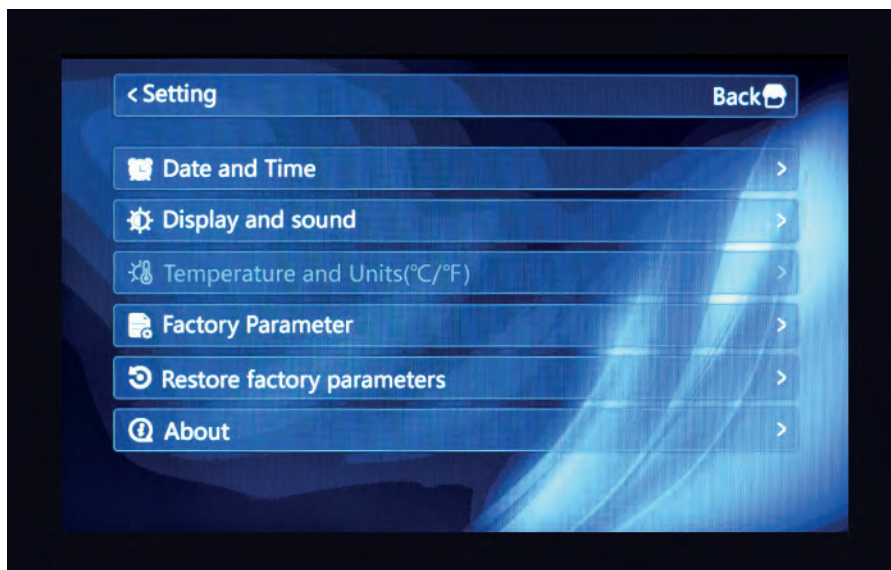

At this point, you can press **< >**, to check the value of each parameter. Click the parameter you want to modify. A page for modifying parameters will appear. On this page, you can see the parameter number, the current parameter value, the set value, and the range of settings. Click the parameter value on the keyboard that appears to enter the set value, then press „Enter.” Click again on the „Enter” on the following page to save the parameters. Click **< >**, on this page to move to the next parameter.

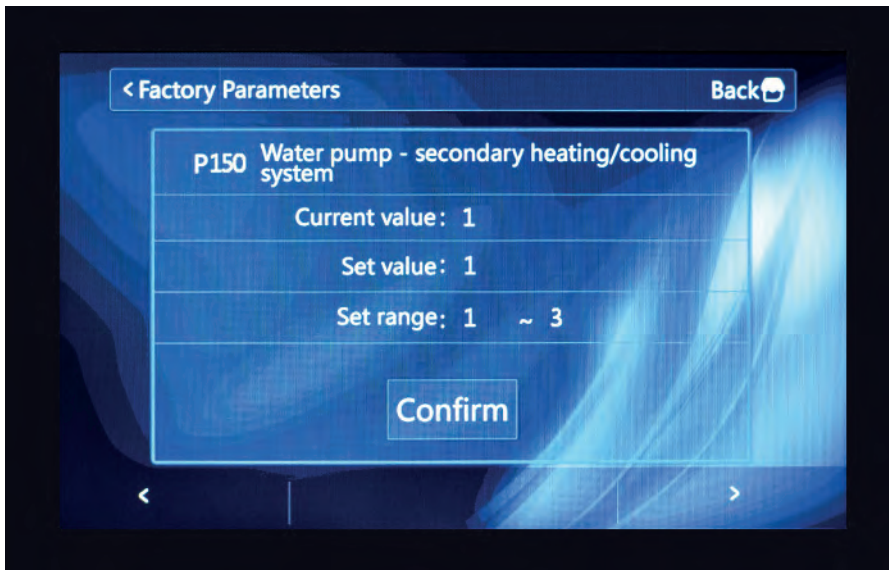

14.9. ERROR DISPLAY

In case of a device malfunction, the  icon will flash on the display. After the fault is resolved, the icon will disappear.

Click the icon to access the error query page. It is possible to display a maximum of 20 current errors and 50 historical errors. The error code 00E03 indicates that 00 is the main unit, and 02, 03, etc., represent the subunits. E03 signifies the error code.

Click „Check historical errors” to view previous errors. Click „Check current error” to view the current error. Click „Clear historical errors” to remove errors from the history.

On the illuminated screen, press „Enter the query page” and click „Enter the error query”.

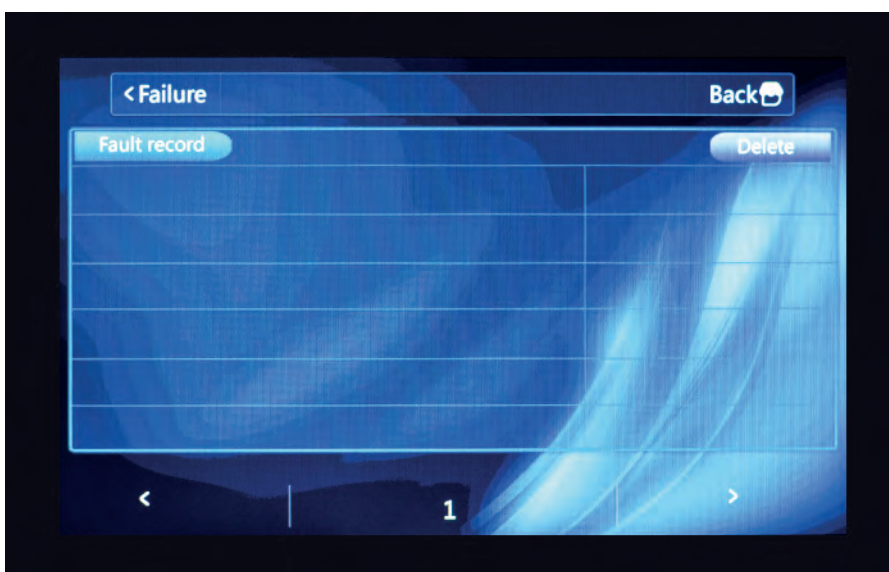

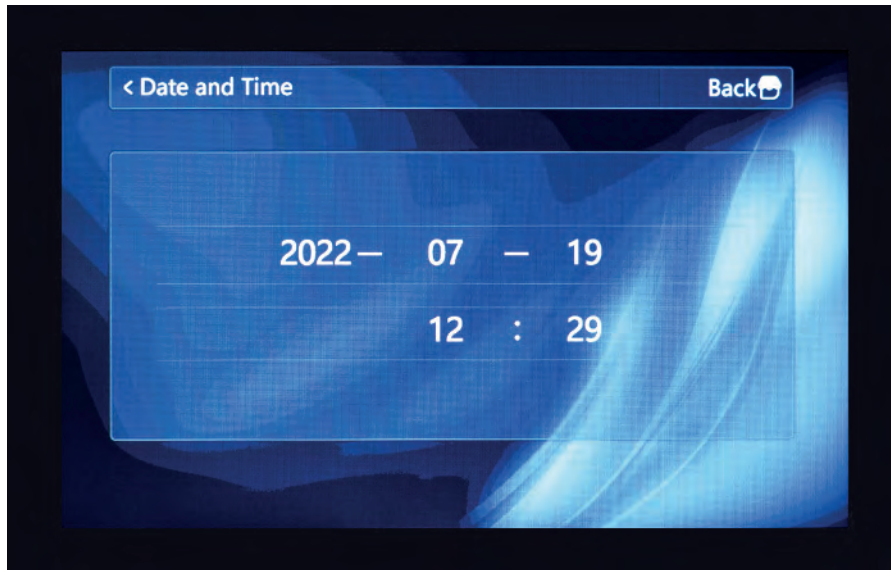

14.10. SETTING THE CLOCK

On the illuminated screen, press  and click  **Date and Time** . Click the appropriate year, month, and day to enter the value on the keyboard, then press „Enter” to save the time.



14.11. SETTING TIME-BASED ON/OFF CONTROL

On the illuminated screen, press  and click  **Date and Time** . If you want to enable weekly timers, click any button from Monday to Sunday to start setting the weekly timers. Click the time period to enter the time settings for that period. Use the keyboard to enter the appropriate time. Click the  button to enable or disable this time segment. Press „OK” to save the settings.

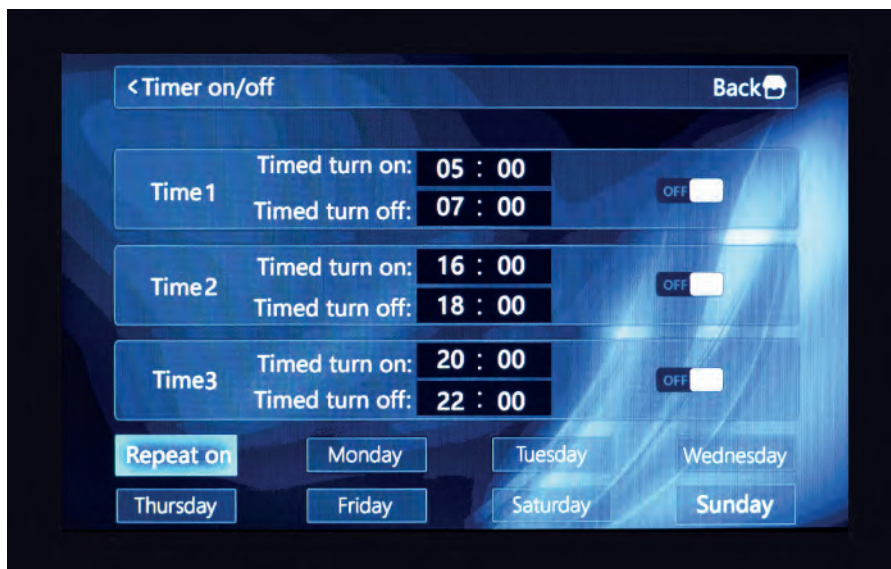



14.12. SETTING THE RETURN WATER TEMPERATURE

On the illuminated screen, press  and then enter the return water temperature settings page by clicking the appropriate button. Click

 to enter the time settings page for return water.

14.13. WI-FI SETTINGS

On the illuminated screen, press , to go to the function selection page. Then , to enter the Wi-Fi operation interface.

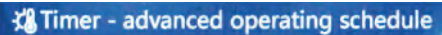

Press to enter the appropriate Wi-Fi network distribution mode. The Wi-Fi mode operates for 3 minutes and will automatically turn off afterward.

14.14. SETTING SCENARIOS (WEEKLY WORK SCHEDULE)

On the illuminated screen, press , to enter the function selection page. Then click ,

to enter the scenario settings screen. You can set up to 6 scenarios for each day. You can set them for daily or weekly time cycles.

Click  to enable or disable this scenario setting. Click the selected scenario segment to modify it. By clicking on the pattern area

 you can change the mode. Click the appropriate value to modify it using the keyboard. Click  to enable or disable this scenario

setting. After completing the settings, press „Enter” to save the confirmation.

Running a scenario: When the device reaches the scheduled time, the operating mode and set temperature will automatically switch to the values scheduled in the work schedule.

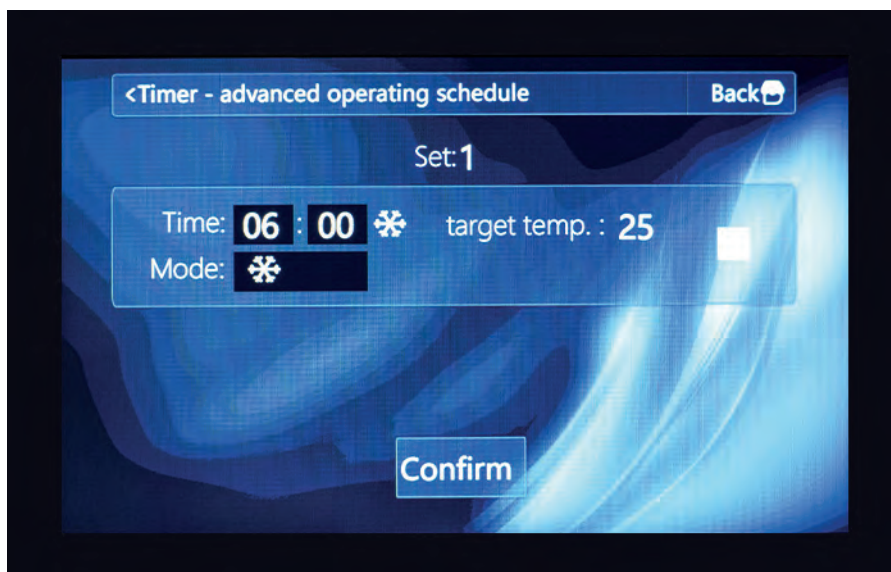

14.15. SEARCHING FOR POWER MODULE PARAMETERS (OPTIONAL)

If the unit is equipped with a battery module, on the illuminated screen, press  , to enter the query page, and then click

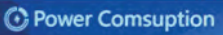



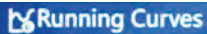

 **Power Consumption** , to enter the power supply unit information search page. You can check total energy consumption, current power, voltage, and current parameters.

14.16. CURRENT WORK CHARTS

On the illuminated screen, press  , to enter the query page, and then click  **Running Curves** , to enter the curve query page.



It records the input water curves, output water curves, compressor frequency, and ambient temperature within 24 hours.

14.17. CURVE SETTINGS

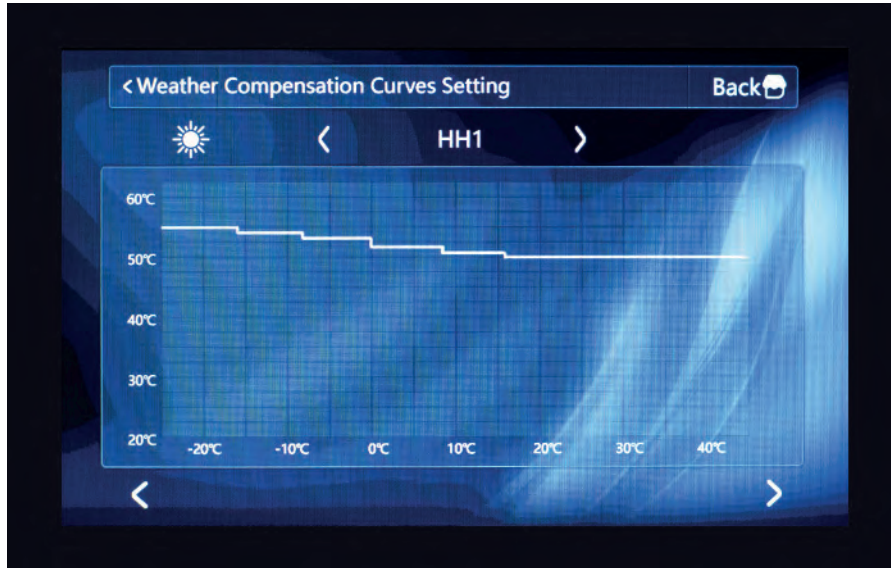
On the illuminated screen, press , to enter the query page, and then click , to enter the curve setting page. Click  , to switch to the curve difference setting mode, and then click  **HH1**  to select different curve control. The parameters of the current curve are displayed in the curve area.

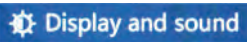

14.18. BRIGHTNESS SETTINGS

On the illuminated screen, press , to enter the settings page, and then click , to enter the brightness settings page. Move the slider to set different brightness levels. Click  , to switch between different languages: Polish, English.

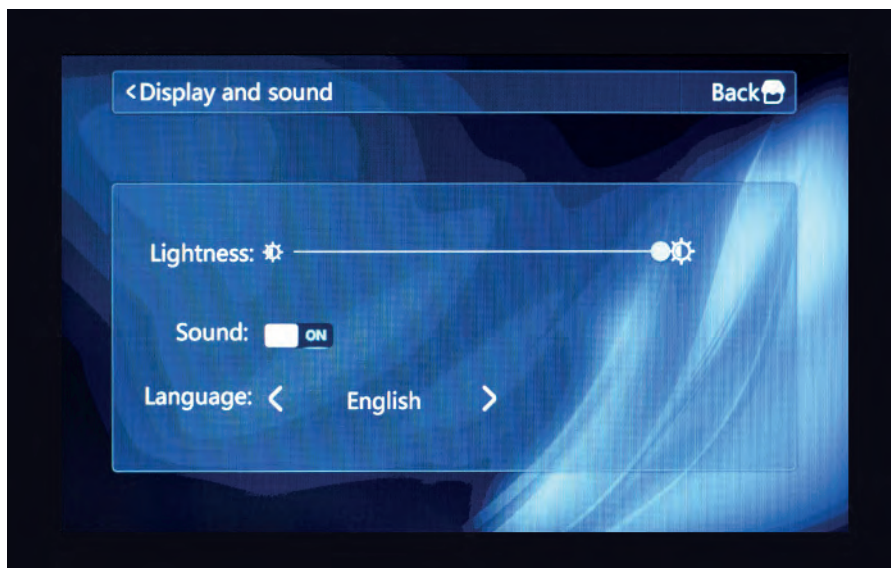

14.19. RESTORE FACTORY SETTINGS

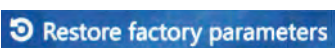
On the illuminated screen, press  , to enter the settings page. Click  , to enter the factory settings restoration page, and then click „YES” to restore factory settings.

14.20. CHECK PROGRAM VERSION

On the illuminated screen, press  , to enter the settings page. Click  , to view the program version numbers for the display and mainboard.

15. CASCADE THERMATEC INSTRUCTIONS

15.1. HARDWARE CONNECTION OF CASCADE UNITS AND SETTING OF DIALING CODE

1. You should wire it according to the diagram below using the appropriate COM1 communication ports.

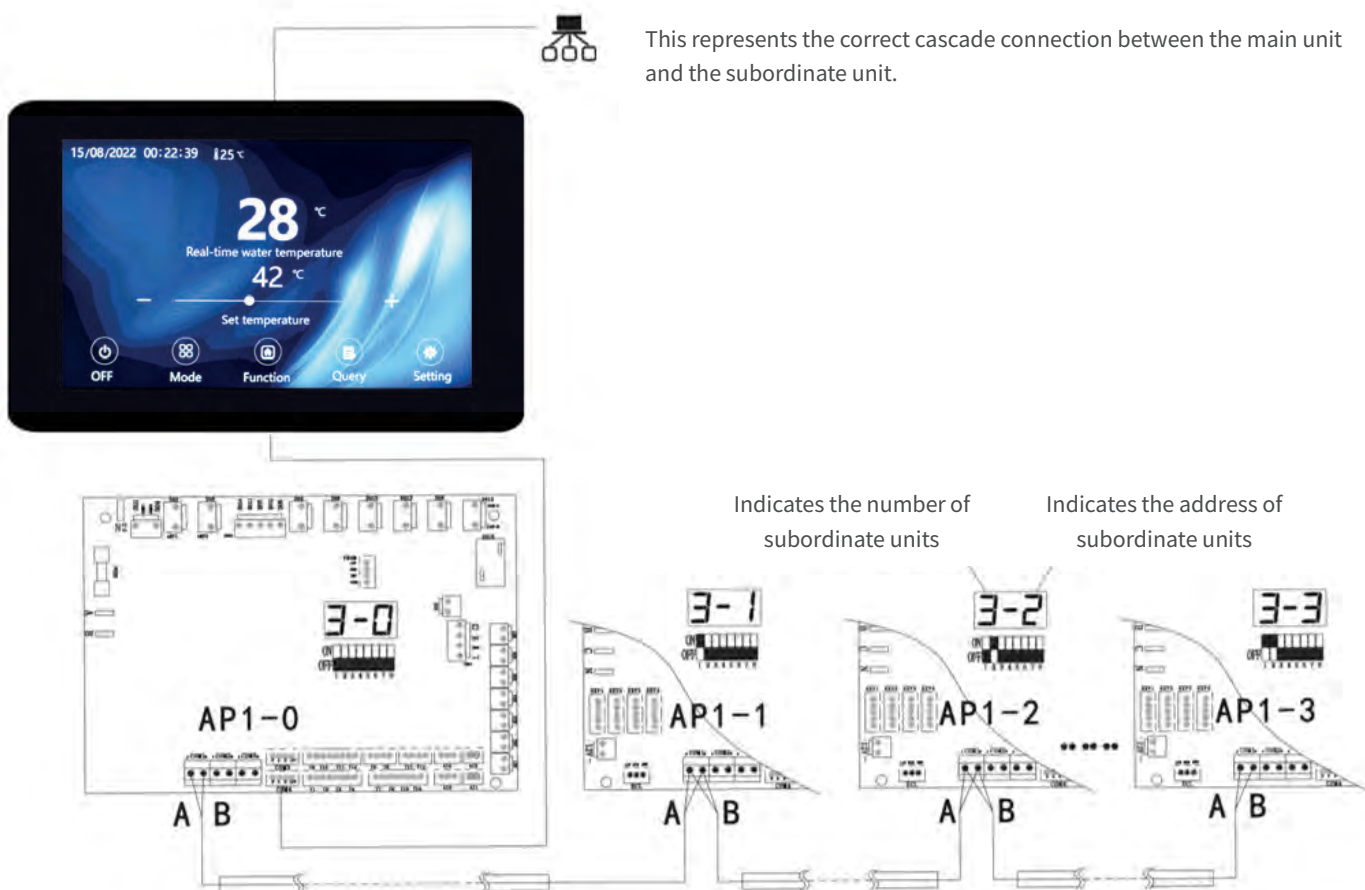

2. The DIP switch is set to the appropriate device address - 00 represents the host; 01, 02, 03, 04, etc. represent subordinate devices.

FOR 50KW CASCADE CODE TABLE						
MODEL NO.	SET 1	SET 2	SET 3	SET 4	MEANING	REMARK
0	OFF	OFF	OFF	OFF	Host	
1	ON	OFF	OFF	OFF	Slave 1	
2	OFF	ON	OFF	OFF	Slave 2	
3	ON	ON	OFF	OFF	Slave 3	
4	OFF	OFF	ON	OFF	Slave 4	
5	ON	OFF	ON	OFF	Slave 5	
6	OFF	ON	ON	OFF	Slave 6	
7	ON	ON	ON	OFF	Slave 7	
8	OFF	OFF	OFF	ON	Slave 8	
9	ON	OFF	OFF	ON	Slave 9	
10	OFF	ON	OFF	ON	Slave 10	
11	ON	ON	OFF	ON	Slave 11	
12	OFF	OFF	ON	ON	Slave 12	
13	ON	OFF	ON	ON	Slave 13	
14	OFF	ON	ON	ON	Slave 14	
15	ON	ON	ON	ON	Slave 15	

3. The device requires a power cycle

When the screen is on, press  , to enter the query page. Click  , to switch to the temperature status = working view.

During cascade network operation, press  , enter the unit number, and click the appropriate online unit number to enter the temperature status query for the respective unit. Units with gray backgrounds (not illuminated) are not online.



16. WI-FI CONNECTION

1. Download and install the Smart Life - Smart Living software.

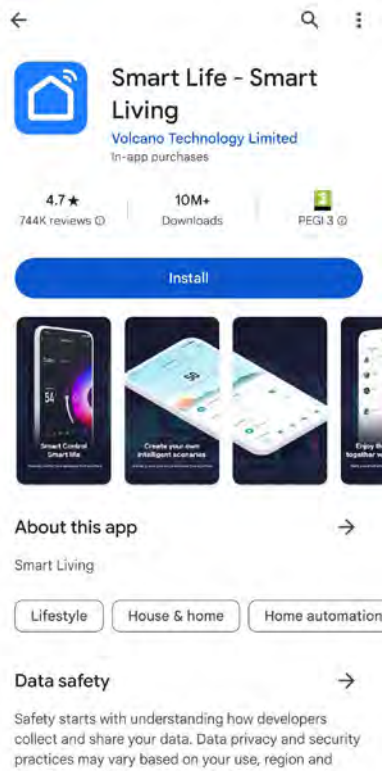

2. Accept the privacy policy.

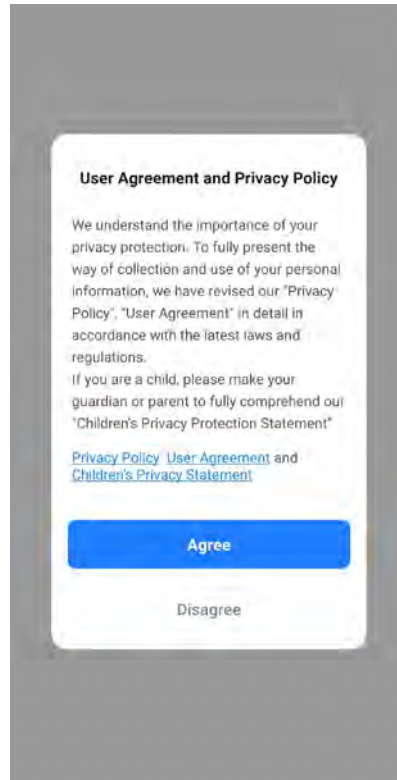

3. Register or log in if you already have an active account.

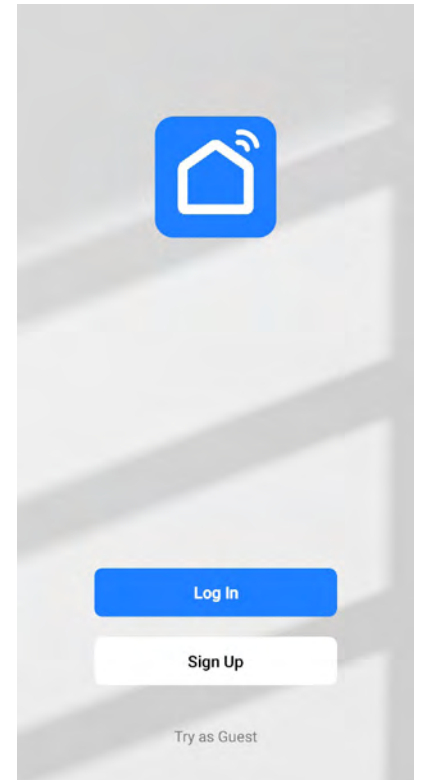

4. During registration, provide the necessary information and give the required consents.

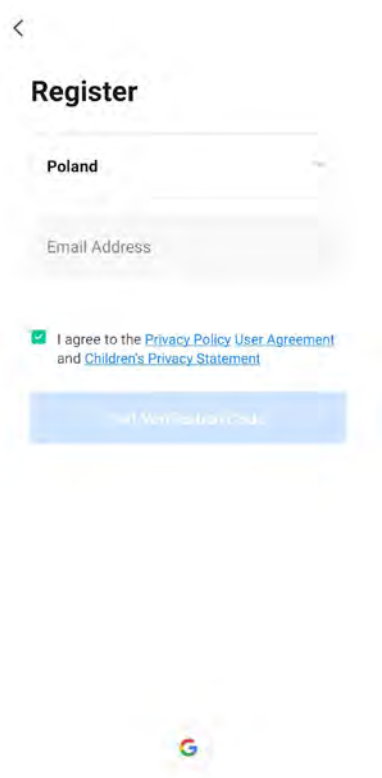

5. Enter the verification code sent to you.

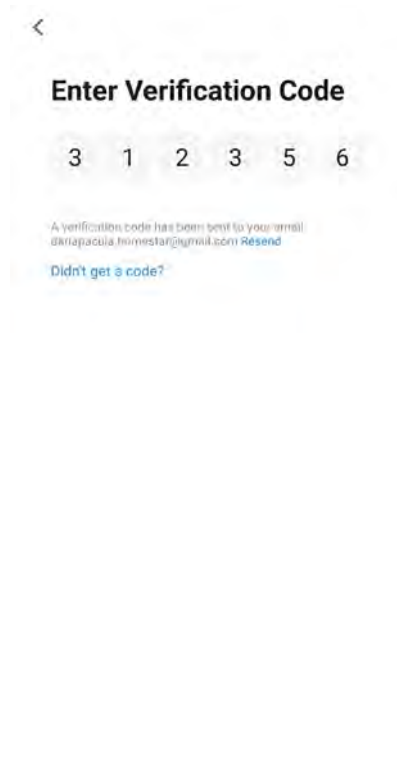

6. After completing the registration, open the application.

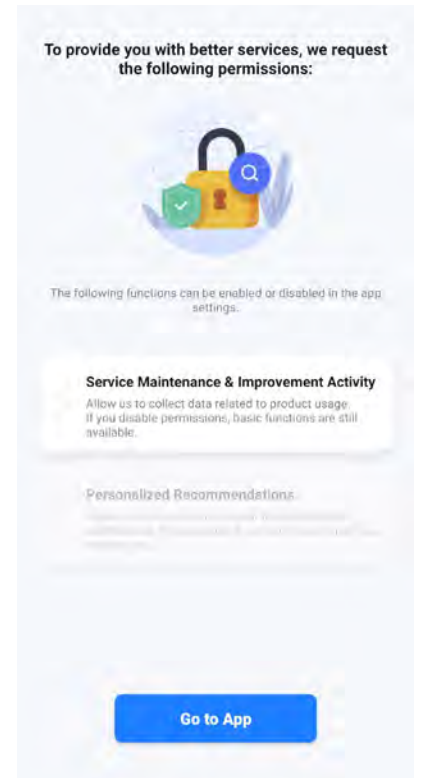

7. Your phone must be connected to a Wi-Fi network. This connection pertains to an internet-accessible Wi-Fi network, not directly to the device's module.



8. After logging in, users can add devices. Device linking: Click on „+” or „Add Device” to initiate the device linking process.

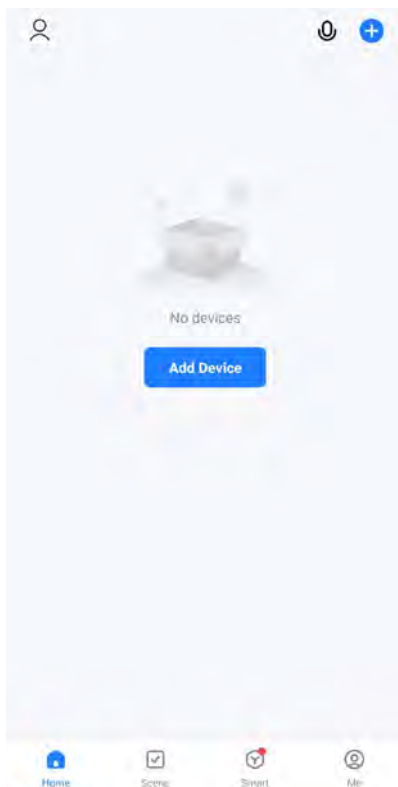

9. The device linking process can be automatic or manual.



10. Once devices are successfully linked, you can proceed to control the heat pump settings.

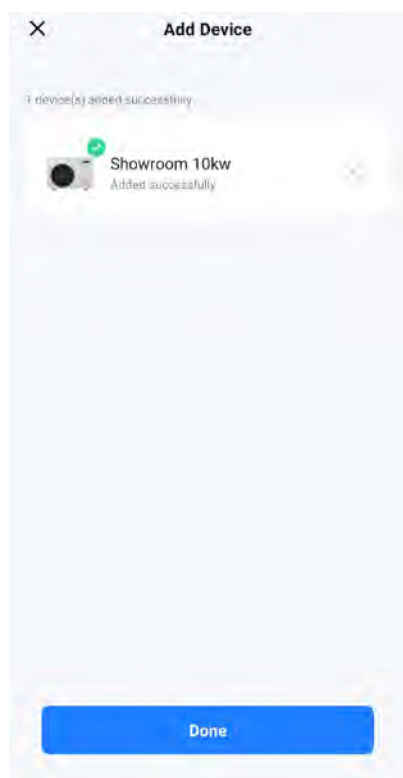

11. You can choose the operating mode and control device power on and off.

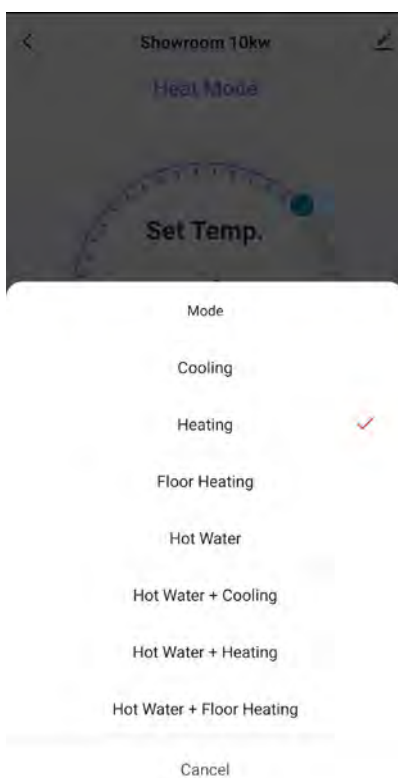

12. You can also adjust temperature settings and device operating times.

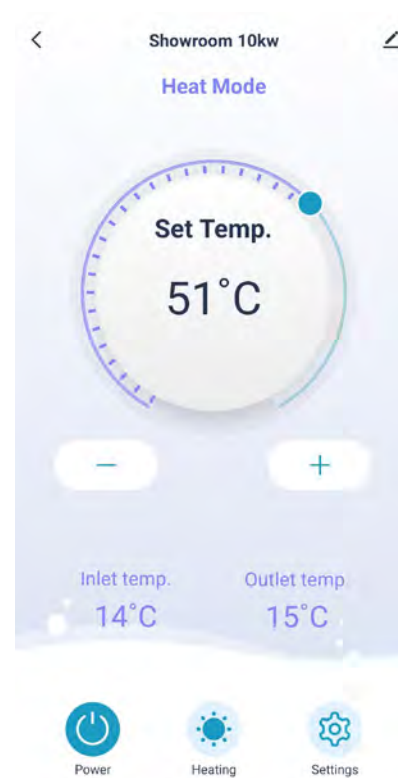

17. DISPOSAL

To dispose of a used heat pump, follow these steps:

1. Empty the heating system. If glycol is used in the heating system, pump the fluid into a container and dispose of it properly.
2. Recover the refrigerant from the system into a container and dispose of it properly.
3. Disassemble individual fastening elements of the device.
4. Dispose of all plastic components and elements appropriately.

18. SERVICE



ATTENTION

Incorrect repairs or improper servicing of the device can damage the equipment and/or cause bodily harm.

To ensure the best quality and safety, all repairs and servicing of the device should be conducted by an Authorized Service Partner of THERMATEC. They will determine the scope and method of repair in consultation with the manufacturer.

NOTES

.....

.....

.....

.....

.....

.....

.....

.....

.....

.....

.....

.....

.....

.....

.....

.....

.....

.....

.....

.....

.....

.....

.....

.....

NOTES

A series of horizontal dotted lines for writing notes.

MANUFACTURER'S STAMP

HOME STAR Sp. z o.o.
ul. Misjonarzy Oblatów 20A
40-129 Katowice
KRS 0000729842 NIP 634 292 88 43



THERMATEC | Home Star sp. z o.o.
Misjonarzy Oblatów MN 20A
40-129 Katowice, Polska [Poland]

Office: (+48) 32 722 02 03
Mobile Phone: (+48) 533 222 223
biuro@thermatec.pl

TH-R290-C50-3P | 50 kW

www.thermatec.eu | www.thermatec.pl | www.thermatec.cz | www.thermatec.fi | www.thermatec.nl

TH-PC_C-INS-2024-05-1